



Safe and  
secure  
with Zantingh

## Pricelist Heating Components

Price from 30-03-2026



## PREFACE

For 90 years, Zantingh B.V. has developed into a leading supplier of professional heating installations, central heating components, and related service activities. Today, Zantingh is younger and more dynamic than ever. From our head office in Rijsenhout and our warehouse in Maasland, the management team and approximately 45 employees remain committed, as always, to delivering high-quality performance. After all, Zantingh's right to exist depends entirely on satisfied customers.

For quite some time, Zantingh has been one of the largest Dutch suppliers in the field of central heating components for greenhouse horticulture. The central heating wholesaler is also active in utility construction and in export markets. Hundreds of installation companies in the Netherlands and abroad are regular customers.

### **Extensive range**

Our product range includes pumps, mixing control equipment, butterfly valves, welding supplies in (stainless) steel, greenhouse heating hose, and fittings. This extensive range is available from stock at two locations: our head office in Rijsenhout and our Westland warehouse in Maasland.

### **Call or email us for more information:**

#### **Zantingh B.V.**

Aarbergerweg 9

1435 CA RIJSENHOUT

Telephone: +31 (0)297 – 21 91 00

Sales staff:

Kees Koopman — +31 (0)297 – 21 91 50

Remco Mol — +31 (0)297 – 21 91 52

Email: [verkoopcv@zantingh.com](mailto:verkoopcv@zantingh.com)

#### **Zantingh Westland**

Oud Camp 6

3155 DL MAASLAND

Telephone: +31 (0)174 – 51 58 22

Sales staff:

Marco Korving — +31 (0)174 – 51 58 22

Bianca Buitelaar — +31(0)174 – 51 58 22

Email: [westland@zantingh.com](mailto:westland@zantingh.com)

General email: [info@zantingh.com](mailto:info@zantingh.com)

Website: [www.zantingh.com](http://www.zantingh.com)

## **General terms and conditions of sale concerning the supply of central heating materials**

### **1. Discounts**

The Zantingh central heating price list shows the gross selling prices, unless stated otherwise. The stated gross selling prices are in principle valid for one calendar year, subject to interim price changes.

### **2. Shipping and administration costs**

For order amounts up to €500 net, excluding VAT, the following applies:

Maximum weight 20 kg: shipping and administration costs €20, excluding VAT

Package heavier than 20 kg (shipped on a pallet): shipping and administration costs €40, excluding VAT

For deliveries within the Netherlands with an order amount of €500 net or more, excluding VAT, no shipping or administration costs will be charged.

**For shipments to addresses outside the Netherlands, the costs will be quoted in advance.**

### **3. Payment**

Net cash, meaning invoice amounts must be credited to our account within 30 days of the invoice date.

### **4. Returns**

Equipment that is not covered by warranty and that has been correctly delivered by Zantingh B.V. in accordance with your specified requirements cannot, in principle, be taken back. If, in special cases, agreement is nevertheless reached between your company and Zantingh B.V. to return goods, those goods must in any case meet the criteria below:

- The equipment must be new (undamaged, unused) and no more than 12 months old after delivery of the relevant item, according to the corresponding official invoice from Zantingh B.V., unless otherwise agreed in the meantime.
- The equipment must be in its original undamaged packaging (and must not be marked or written on).

Goods manufactured and/or supplied as a special customer order cannot be returned.

In such a special case, provided the above criteria are met, at most 50% of the net value of the original invoice on which the item(s) were supplied by Zantingh B.V. will be reimbursed.

A minimum invoice value of €500 net, excluding VAT, applies, meaning the minimum credit amount is €250 net, excluding VAT.

# Contents

	<b>Page</b>
<b>Chapter 1 - Radiator fittings, thermostats, pressure switches</b>	<b>1</b>
Valve RAV	2
Valve RAVV	2
Valve RA-FN	3
Thermostatic sensor RA	3
Differential pressure regulators AVDA / AVDO	4
Room thermostats	6
New-Line radiator fittings	4
Danfoss pressure switches and thermostats	5 + 6
Siemens thermostats RAK	7
Siemens thermostats RAZ	8
<b>CHAPTER 2 - Centra, Honeywell mixing and control equipment</b>	<b>9</b>
Mixing valves DR	10
Dimensions of mixer taps DR	11
Mixing valves ZR	12
Dimensions of mixer taps ZR	13
Servo motors VMM / VMK	14
Honeywell mixing valves	15
Honeywell servo motors	15
Accessories for ZG controllers	16
<b>CHAPTER 3 - Circulation pumps Johnson, Grundfos</b>	<b>17</b>
SPX CombiLine pumps	18-20
Danfoss frequency converters	20
Grundfos circulation pumps type MAGNA	22
Grundfos circulation pumps type TP	23 + 24
Grundfos circulation pumps type ALPHA	24
Grundfos submersible pumps type KP	24
<b>CHAPTER 4 - Valves</b>	<b>25</b>
EBRO butterfly valves Z011-A	26
EBRO levers / worm gearboxes	27
Dimensions of butterfly valves	27
EBRO butterfly valves Z011-A gas version	28
EBRO butterfly valves with motor	29
EBRO servo motors	29
EBRO pneumatic actuators	30
EBRO butterfly valves Z014-A	30
EBRO non-return valves type CP	31
EBRO non-return valves type DC	31
Gate valves brass	32
Gate valves Rot-Gelb	33
Non-return valves Rot-Gelb	34
Non-return valves Valstop	34
Ball valves	35
Ball valves with motor	35
Gas ball valves	36
Solenoid valves Lucifer	36
Adjustment valves STAF	37

# Contents

	<b>Page</b>
<b>CHAPTER 5 - Mounting materials + central heating pipe</b>	<b>38</b>
Malleable fittings black	39-43
Malleable fittings galvanized	44-48
Compression fittings VSH	49-52
Flamco materials	53
Suspension materials	53
Central heating pipe	54
Copper pipe	54
<b>CHAPTER 6 - Welding supplies</b>	<b>55</b>
Welding elbows	56
Weld reducers	56 + 57
Welding saddles	58
Welding shoes	58
Welded bottoms	59
Welding plates	60
Weld tees	60
Weld sockets	61
Pipe nipples	61
Headpieces	62
Pipe brackets / clamps	62
Compensators stainless steel + rubber	63 + 64
<b>CHAPTER 7 - Expansion tanks</b>	<b>65</b>
Expansion tanks	66
<b>CHAPTER 8 - Thermometers + pressure gauges</b>	<b>67</b>
Thermometers	68
Pressure gauges	69
<b>CHAPTER 9 - Weight safety devices, gas filters and gas pressure regulators</b>	<b>70</b>
Weight safety devices	71
Gas filters	71
Gas pressure regulators Jeavons	72
Relief valves	73
Safety valves	73
<b>CHAPTER 10 - Greenhouse heating hose, Viktor chain and accessories</b>	<b>74</b>
Greenhouse heating hose	75
Astore couplings	75
Geka couplings	75
Unifit hose couplings	75
Valvo couplings	75
Hose clamps	76
Hose tails	76
Viktor chain	77
S-hooks	77

# Contents

	<b>Page</b>
<b>CHAPTER 11 - Flanges, gaskets, sealing and fastening materials</b>	<b>78</b>
Pre-weld flanges	79 + 80
Threaded flanges	80
Blind flanges	81
Flat weld flanges	81
Gasket sets	82
Klinger gasket rings	83
Rubber gasket rings	84
Graphite gaskets	84
Bolts	85 + 86
Nuts	86
Washers	87
Spring washers	87
Threaded rods	87
<b>CHAPTER 12 - Miscellaneous materials</b>	<b>88</b>
Sight glasses, devices, parts	89
Syphons	89
Air vents	89
Presscon protector	90
Low water protections	90
Air pressure switches	90
Pipe protection materials and tapes	91
Densolene tape	91
Tape	91
Foil	91
Aluminium adhesive tape	91
Grease tape	91
Tar tape	91
Leak detector	91
Hemp	91
Loctite	92
Caldeplast	92
Domestic heating accessories	92
Overstortventielen	92
Fill and drain valves	92
Ballofix	92
Plastic plug	92
<b>CHAPTER 13 - Fan heaters</b>	<b>93</b>
Fan heaters type LH	94
<b>CHAPTER 14 - SPX pumps</b>	<b>95</b>
CL + CBH pumps various voltages	96-117

# CHAPTER 1

*Radiator fittings*

*Thermostats*

*Pressure switches*





**ZANTINGH**

**DANFOSS RADIATOR FITTINGS**

**Valves for thermostatic controllers Type RAV**

The two-way valve RAV ensures precise and constant temperature control in combination with the thermostatic temperature controllers RAVV.

The RAV two-way valve is equipped with internal thread and point connection.

Technical data:

Maximum water temperature	: 120°C.
Proof	: 16 bar
Maximum operating pressure	: 10 bar

**Two-way valve RAV Recht**

Item no.	Description	Type	Connection size	KVS value	Price €
4400013	Therm.valve	RAV 15/8	1/2"	1,6	44,90
4400014	Therm.valve	RAV 20/8	3/4"	2,3	59,00
4400015	Therm.valve	RAV 25/8	1"	2,6	105,00
4400016	Therm.valve	RAV 15/2	1/2"	2,9	62,30
4400017	Therm.valve	RAV 20/2	3/4"	4,2	85,50



**Two-way valve RAV Haaks**

Item no.	Description	Type	Connection size	KVS value	Price €
4400010	Therm.valve	RAV 20/8	3/4"	2,3	48,30
4400011	Therm.valve	RAV 25/8	1"	2,6	97,30

**Temperature controller for air and water**

The RAVV temperature controller is a thermostatic controller suitable for various applications. Used in combination with the RAV valves.

The RAVV control element is equipped with a copper rod probe for temperature measurement in water and air. Immersion tube is available separately.

Technical data:

Max. sensor temperature	: 120°C.
Setting scale	: 1 ... 5

**RAVV control element**

Item no.	Description	Type	Temp.	Capillary	Price €
4400033	Therm.Sensor	RAVK 013U8063	25 ... 65°C	2.0 mtr.	212,00
4400034	Therm.Sensor	RAVK 013U8072	25 ... 45°C	2.0 mtr.	212,00
4400035	Therm.Sensor	RAVK 003L3530	10 ... 30°C	2.0 mtr.	209,00
4400032	Immersion tube	brass			82,20

**Replacement models**

4400025	Therm.probe RAV 2960	with built-in probe, clamp 34 mm			42,60
4400026	Therm.probe RAV 2962	Remote sensor, clamp 34 mm			63,60

### Valves for thermostatic controllers type RA-FN

The two-way valves RA-FN have a fixed passage for general application in heating and cooling installations. The RA-FN two-way valve is equipped with female thread and coupling connection.



**Technical data:**

Maximum water temperature	: 120°C.
Proof	: 16 bar
Maximum operating pressure	: 10 bar

### Radiator valves RA-FN Straight (not adjustable)

Item no.	Description	Type	Connection size	KVS value	Price €
4403001	Therm.valve	RA-FN 15	1/2"	0,9	22,50
4403002	Therm.valve	RA-FN 20	3/4"	1,4	28,70
4403003	Therm.valve	RA-FN 25	1"	1,4	51,00

### Radiator valves RA-FN Angled (not adjustable)

Item no.	Description	Type	Connection size	KVS value	Price €
4403005	Therm.valve	RA-FN 15	1/2"	0,9	22,50

### Radiator valves RA-FN Angled U.K. (not adjustable)

Item no.	Description	Type	Connection size	KVS value	Price €
4403008	Therm.valve	RA-FN 10	3/8 UK	0,65	22,50
4403009	Therm.valve	RA-FN 15	1/2 UK	0,9	24,20
4403010	Therm.valve	RA-FN 20	3/4 UK	1	30,00
4403019	Compression set for RA-FN		1/2" X 15 mm		3,90
4403020	Therm.valve Dub.HKS	RA-N 15	1/2" right	0,9	36,10
4403021	Therm.valve Dub.HKS	RA-N 15	1/2" left	0,9	36,10

### Standard control element RA-2000 series.

Standard control element is suitable for general applications. The element is equipped with click connection with theft protection.

Adjustment range	: 5 ... 26°C
Setting scale	: 1 ... 5
Ambient temperature max.	: 60°C

Item no.	Description	Type	Capillary length	Price €
4400024	Therm.Sensor	RA 2980	Built-in probe	30,20

### With remote control.

Adjustment range	: 8 ... 28°C
Setting scale	: 1 ... 5
Ambient temperature max.	: 30°C above setting.

Item no.	Description	Type	Capillary length	Price €
4403015	Therm.Sensor	RA 5062	0 ... 2 mtr.	120,00
4403016	Therm.Sensor	RA 5065	0 ... 5 mtr.	130,00

## DANFOSS DIFFERENTIAL PRESSURE REGULATORS

<b>Membrane-controlled differential pressure regulator</b>					
Membrane-controlled differential pressure regulators. Operation: valve opens with increasing differential pressure without auxiliary energy. Regulator equipped with 2 impulse lines and 2 adapter nipples 1/4 flare x 3/8 R.					
Technical data: Maximum working pressure : 10 bar Maximum differential pressure : 1.2 bar Max. medium temperature : 110°C Adjustment range : 0,1 ... 1.2 bar					
Item no.	Description	Type	Connection size	KVS value	Price €
4401001	Differential press. regulator	AVDA 20	3/4"	3,4	607,00
4401002	Differential press. regulator	AVDA 25	1"	5,5	642,00



<b>Spring-loaded differential pressure regulator</b>					
Spring-loaded differential pressure regulators. This differential pressure regulator is intended for small installations up to approx. 65kW. With an increasing pressure difference, the spring-loaded valve opens, causing a part of the of the water is overflowed into the return. Placement about 6 meters from the central heating device.					
Technical data: Maximum working pressure : 10 bar Maximum differential pressure : 0.5 bar Proof : 16 bar Max. medium temperature : 120°C. Adjustment range : 0,05 ... 0.5 bar					
Item no.	Description	Type	Connection size	Connection	Price €
4404003	Differential press. regulator	AVDO 15R 6018	bi x bu 1/2"	Law	97,30
4404007	Differential press. regulator	AVDO 20R 6023	bi x bu 3/4"	Law	102,00
4404011	Differential press. regulator	AVDO 25R 6028	bi x bu 1"	Law	145,00



## NEW-LINE RADIATOR FITTINGS

<b>Radiator couplings</b>					
Item no.	Description	Facts	Connection size	Connection	Price €
4500002	Radiator coupling	Brass	3/4"	Perpendicular	6,51
4500003	Radiator coupling	Brass	1"	Perpendicular	11,98
4500005	Radiator coupling	Brass	1/2"	Law	3,82
4500006	Radiator coupling	Brass	3/4"	Law	5,37
4500050	Radiator bend	Chrome	1/2"	Bend	10,36

<b>Foot valves Chrome-plated version Heimeier</b>					
Item no.	Description	Facts	Connection size	Connection	Price €
4500051	Foot valve	Chrome	3/8"	Law	14,59
4500052	Foot valve	Chrome	1/2"	Perpendicular	13,59
4500053	Compression set		1/2" X 15 MM		2,08

## HONEYWELL PRESSURE SWITCHES

### Pressuretrol pressure regulator for proportional control. (Series 90)

For control of air, non-flammable gases and liquids temperatures.

Bellows : Brass  
 Output signal : 135 ohm potentiometer.  
 Nutrition : 24 V, 50 Hz.



Item no.	Description	Type	Adjustment range	Max. pressure	Price €
1907001	Pressure switch	L91B1035/H	0-100 kPa	140 kPa	390,00
1907003	Pressure switch	L91B1050/h	34-1000 kPa	1580 kPa	On request
1907004	Pressure switch	L91B1068/h	70-2000 kPa	2280 kPa	371,00

## DANFOSS PRESSURE SWITCHES

### Industrial pressure switches

Pressure controls for general applications. Control, control and alarm applications.

Media temperature : Max 100°C, for RT113 max. 90°C  
 Contact load : 10A, 380Vac ohms  
 Contact system : Single-pole changeover contact



Item no.	Description	Type	Adjustment range	Price €
1700000	Pressure switch	RT 5	4 – 17 bar	375,00
1700009	Pressure switch	RT 110	0.2 – 3 bar	410,00
1700001	Pressure switch	RT 112	0.1 – 1.1 bar	410,00
1700002	Pressure switch	RT 113	0.0 – 0.3 bar	559,00
1700003	Pressure switch	RT 116	1.0 – 10 bar	410,00
1700004	Pressure switch	RT 200	0.2 – 6 bar	410,00

### Differential pressure switches

Pressure controls for general applications. Control, control and alarm applications.

Media temperature : Max 100°C.  
 Contact load : 10A, 380Vac ohms  
 Contact system : Single-pole changeover contact

Item no.	Description	Type	Adjustment range	Price €
1700008	Differential press. pressure	RT 262 AL	0.1 – 1.5 bar	927,00
1700007	Differential press. pressure	RT 263 AL	0.1 – 1.0 bar	1.090,00
1700006	Contact system for RT			144,00
1700017	Minus pressure switch	BCP3L	0.0 - 6.0 bar	493,00
1700018	Max Pressure Switchat	BCP3H	0.0 - 6.0 bar	493,00
1700019	Minus pressure switch	BCP2L	0.0 - 2.5 bar	493,00

**DANFOSS THERMOSTATS**

<b>Thermostats with cylindrical spacer and capillary</b>					
Item no.	Description	Type	Temp. setting		Price €
1600009	Thermostat	RT 3	- 25°C...+ 15°C		408,00
1600001	Thermostat	RT 14	- 5°C...+ 30°C		408,00
1600015	Thermostat	RT 26	- 5°C...+ 50°C		408,00
1600002	Thermostat	RT 101	+ 25°C... + 90°C		399,00
1600028	Thermostat	RT 107	+ 70°C... + 150°C		431,00
1600029	Thermostat	RT 108	+ 30°C...+ 140°C		501,00

<b>Thermostat with room sensor</b>					
Item no.	Description	Type	Temp. setting		Price €
1600000	Thermostat	RT 4	- 5°C...+ 30°C		347,00
1600027	Thermostat	RT 102	+ 25°C...+ 90°C		481,00
1600003	Thermostat	RT 103	+ 10°C...+ 45°C		420,00

  

<b>Thermostat with capillary probe</b>					
Item no.	Description	Type	Temp. setting	Cap.	Price €
1600052	Frost thermostat	KP 61	- 30°C...+ 15°C	2 mtr.	154,00
1600053	Frost thermostat	KP 61	- 30°C...+ 15°C	5 mtr.	219,00



<b>Mechanical room thermostats</b>					
<p>These room thermostats are particularly suitable for switching electric heating elements, pumps, burners and fans.</p> <p>The temperature control is less accurate than the electronic thermostats.</p> <p>Not suitable for comfort installations</p> <p>Technical data:</p> <p>Connection : 3- or 4 wire</p> <p>Adjustment range : 8 ... 30°C</p> <p>Color : white</p>					
Item no.	Description	Type	Thermometer	Nutrition	Price €
1600042	Thermostat	RMT 24	No	24 V.	94,10
1600045	Thermostat	RMT 24 T	Yes	24 V.	122,00
1600040	Thermostat	RMT 230	No	230 B.V.	84,60
1600041	Thermostat	RMT 230T	Yes	230 B.V.	113,00
1600047	Thermostat	KPS 79	Yes	230 B.V.	546,00
1600048	Thermostat	KPS 81	Yes	230 B.V.	546,00



<b>SIEMENS THERMOSTATS TYPE RAK</b>				
<p>For use in heat generation plants and other applications</p> <p>within the AC/CV technique.</p> <p>Three mounting options: mounting on a pipe (contact sensor), in a Pipe (immersion sensor 100mm), wall mounting (capillary 70cm)</p> <p>An immersion tube and clamping band are included.</p> <p>Technical data:</p> <p>Switching capacity contact 1-2 10(2.5) A, 250Vac</p> <p>Switching capacity contact 1-3 6(2.5) A, 250Vac</p> <p>Degree of protection IP 43</p> <p>Time constant according to DIN 3440</p> <p>Thermostat with button</p> <p>Thermostat is adjustable from the outside (TR)</p> <p>Adjustable from 15-95°C</p>				
Item no.	Description	Type	Temp.	
1601200	Thermostat	RAK-TR-1000B	15 ... 95°C	91,40
<b>Blind thermostat</b>				
<p>Thermostat setting is behind cover (TW)</p> <p>Checking the set switching value through a window in the lid</p> <p>Adjustable from 15-95°C or 40-120°C</p>				
Item no.	Description	Type	Temp.	Price €
1601212	Thermostat	RAK-TW-1000HB	15 ... 95°C	103,00
1601202	Thermostat	RAK-TW-1200B	40 ... 120°C	89,70
<b>Safety temperature limiter</b>				
<p>Max. thermostat (STB)</p> <p>Fixed switch-off temperature 110°C</p> <p>Mechanical locking, unlocking covered by external</p> <p>Separate screw connection.</p> <p>Checking the switching value through a window in the lid</p>				
Item no.	Description	Type	Temp.	Price €
1601203	Thermostat	RAK-ST.030FP	110°C	96,40
<b>Protective sleeves</b>				
Item no.	Description	Type	Material	Price €
1601099	Protective sleeve	for RAK	Ms63 nickel plated	20,50
1601100	Protective sleeve	For RAZ	Cr.Ni.MO	30,00

## SIEMENS THERMOSTATS TYPE RAZ

Combination of two thermostats, or a thermostat and maximum thermostat.

Two mounting options: in a pipe (immersion sensor 100mm), wall mounting (capillary 70cm)

A double immersion tube is included.

Technical data:

Switching capacity contact 1-2 10(2.5) A, 250Vac

Switching capacity contact 1-3 6(2.5) A, 250Vac

Degree of protection IP 43

Time constant according to DIN 3440

Double thermostat RAZ-TW.1000

Thermostat is adjustable from the outside (TR)

Thermostat setting is behind cover (TW)

Checking the set switching value through a window in the lid

Adjustable from 15-95°C



Item no.	Description	Type	Temp.	Price €
1601204	Thermostat	RAZ-TW.1000P	15 ... 95°C	156,00

Double thermostat and maximum thermostat RAZ-ST.030FP

Thermostat is adjustable from the outside (TR), adjustable from 15-95°C

Max. thermostat (STB), fixed switch-off temperature 110°C, mechanical locking, unlocking covered by external, Removable screw closure.

Switching capacity contact 11-12 10(2.5) A, 250Vac

Item no.	Description	Type	Temp.	Price €
1601205	Thermostat	RAZ-ST.030FP	15 ... 95°C	179,70

## CHAPTER 2

*Centers mixer taps*

*Honeywell control valves*

*Control equipment*



### Three-way mixer with straight or angled passage PN6

**Application:**

Mixing control of supply water temperature in heating, air treatment and horticultural applications.

**Technical data:**

Ports	: female thread/flange connections according to DIN2531
Home	: cast iron
Swivel plug	: chrome-plated cast iron
Rotation angle	: 90°
Sealing	: double o-ring
Medium	: heating water, glycol-water mixture (max. 50% glycol according to VDI 2035)
Temperature	: + 2... 130°C; 6 bar

### With female thread connection and straight passage

Item no.	Description	Type	Connection size	KVS value	Price €
1800023	Mixing valve	DR 20 GMLA	DN 20	6,3	139,30
1800025	Mixing valve	DR 25 GMLA	DN 25	10	145,30
1800027	Mixing valve	DR 32 GMLA	DN 32	16	154,60
1800029	Mixing valve	DR40 GMLA	DN 40	25	169,20



### With flange connection and straight passage

Item no.	Description	Type	Connection size	KVS value	Price €
1800033	Mixing valve	DR 20 GFLA	DN 20	6,3	157,40
1800035	Mixing valve	DR 25 GFLA	DN 25	10	163,30
1800037	Mixing valve	DR 32 GFLA	DN 32	16	176,90
1800039	Mixing valve	DR 40 GFLA	DN 40	25	191,80
1800041	Mixing valve	DR 50 GFLA	DN 50	40	227,00
1800043	Mixing valve	DR 65 GFLA	DN 65	63	275,00
1800045	Mixing valve	DR 80 GFLA	DN 80	100	423,00
1800047	Mixing valve	DR 100 GFLA	DN 100	160	542,00
1800049	Mixing valve	DR 125 GFLA	DN 125	250	927,00
1800048	Mixing valve	DR 150 GFLA	DN 150	630	1.735,00
1800044	Mixing valve	DR 200 GFLA1	DN 200	1000	2.653,00
1800046	Mixing valve	DR 200 GFLA	DN 200	1600	2.314,00



### With flange connection and right-angled passage

Item no.	Description	Type	Connection size	KVS value	Price €
1800088	Distribution valve	DR 65 FA	DN 65	63	275,00
1800087	Distribution valve	DR 80 FA	DN 80	100	423,00
1800082	Distribution valve	DR 100 FA	DN 100	160	556,00
1800096	Distribution valve	DR 125 FA	DN 125	250	1.377,00



### Separate internals 3-way mixer taps

Item no.	Description	Type	Price €
1801086	Interior	DR 50	215,10
1801087	Interior	DR 65	273,00
1801088	Interior	DR 80	427,00
1801089	Interior	DR 100	551,00
1801092	Interior	DR 125	791,00
1801091	Interior	DR 150	894,00
1801075	Interior	DR 200	1.133,00

## DIMENSIONS OF MIXER TAPS

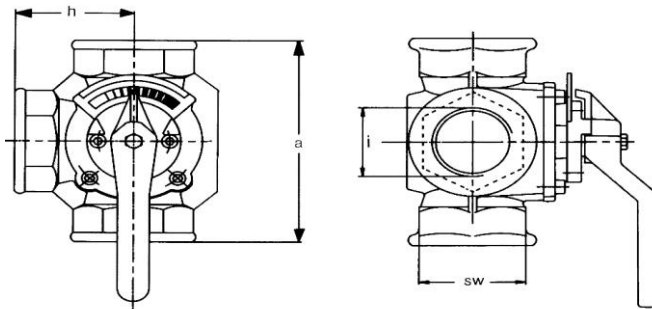

**With FEMALE thread connection and STRAIGHT and ANGLED passage**

TYPE	a	c	sw	h	i	Weight Net
DR15GMLA	110	179	41	55,00	R 1/2'	2.2 kg
DR20GMLA	110	179	46	55,00	R 3/4'	2.3 kg
DR25GMLA	115	179	50	58,00	R 1'	2.4 kg
DR32GMLA	140	188	60	70,00	R 1 1/4'	4.1 kg
DR40GMLA	150	188	65	75,00	R 1 1/2'	4.3 kg

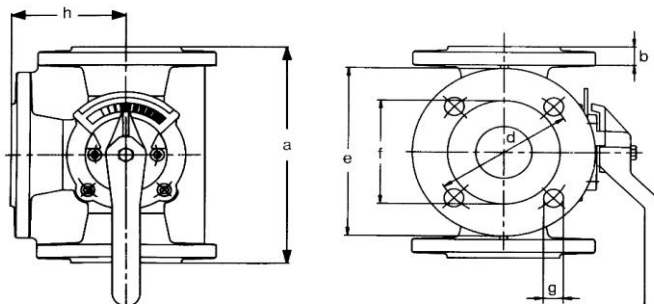

**With FLANGE connection and STRAIGHT and RIGHT ANGLE passage**

TYPE	a	b	e	g	h	Weight Net
DR20GFLA	140	15	90	4 x 11	70	3.5 kg
DR25GFLA	150	15	100	4 x 11	75	4.0 kg
DR32GFLA	: 1 ... 5	17	120	4 x 14	80	6.6 kg
DR40GFLA/FA	170	16	130	4 x 14	85	7.1 kg
DR50GFLA/FA	190	16	140	4 x 14	95	9.8 kg
DR65GFLA/FA	210	16	160	4 x 14	105	12.3 kg
DR80GFLA/FA	250	18	190	4 x 18	125	21.4 kg
DR100GFLA/FA	270	18	210	4 x 18	135	26.5 kg
DR125GFLA/FA	310	20	240	8 x 18	155	42.0 kg
DR150GFLA/FA	330	20	265	8 x 18	165	49.0 kg
DR200GFLA	390	22	320	8 X 18	195	73.0 kg

Four-way mixer PN6	
Application:	Mixing control of supply water temperature in heating, air treatment and horticultural applications.
Technical data:	
Ports	: female thread/flange connections according to DIN2531
Home	: cast iron
Twist plug:	: chrome-plated cast iron
Rotation angle	: 90°
Sealing	: double o-ring
Medium	: heating water, glycol-water mixture (max. 50% glycol according to VDI 2035)
Temperature	: + 2... 130°C; 6 bar

Four-way mixer PN 6 with thread connection					
Item no.	Description	Type	Connection size	KVS value	Price €
1800050	Mixing valve	ZR 15 MA	DN 15	4,00	164,00
1800051	Mixing valve	ZR 20 MA	DN 20	6,30	164,00
1800052	Mixing valve	ZR 25 MA	DN 25	10,00	169,90
1800053	Mixing valve	ZR 32 MA	DN 32	16,00	177,80
1800054	Mixing valve	ZR 40 MA	DN 40	25,00	194,40

Four-way mixer PN 6 with flange connection					
Item no.	Description	Type	Connection size	KVS value	Price €
1800057	Mixing valve	ZR 25 FA	DN 25	10,00	189,90
1800058	Mixing valve	ZR 32 FA	DN 32	16,00	201,70
1800059	Mixing valve	ZR 40 FA	DN 40	25,00	232,00
1800060	Mixing valve	ZR 50 FA	DN 50	40,00	262,00
1800061	Mixing valve	ZR 65 FA	DN 65	63,00	322,00
1800062	Mixing valve	ZR 80 FA	DN 80	100,00	497,00
1800063	Mixing valve	ZR 100 FA	DN 100	160,00	706,00
1800064	Mixing valve	ZF 125 FA	DN 125	250,00	1.494,00
1800065	Mixing valve	ZR 150 FA	DN 150	400,00	1.573,00
1800066	Mixing valve	ZR 200 FA	DN 200	630,00	1.872,00

Separate internals 4-way mixer taps			
Item no.	Description	Type	Price €
1801049	Interior	ZR 50	215,10
1801050	Interior	ZR 65	273,00
1801051	Interior	ZR 80	462,00
1801052	Interior	ZR 100	551,00
1801093	Interior	ZR 125	791,00

Repair kit for mixing valve				
Item no.	Description	Type	Connection size	Price €
1802001	Repair kit	DR/ZR	for DN 15-40	79,25
1802002	Repair kit	DR/ZR	for DN 50-65	90,70
1802003	Repair kit	DR/ZR	for DN 80-100	100,20
1802004	Repair kit	DR/ZR	for DN 125-200	100,20
1802005	O-ring with grease		for all types	9,80

## DIMENSIONS OF MIXER TAPS

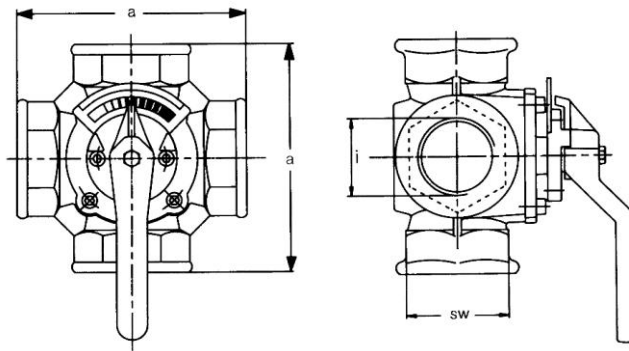

### With FEMALE thread connection

TYPE	a	C	SW	h	l	Weight Net
ZR15MA	110	179	41	55,00	R 1/2'	2.4 kg
ZR20MA	110	179	46	55,00	R 3/4'	2.5 kg
ZR25MA	115	179	50	58,00	R 1'	2.6 kg
ZR32MA	140	188	60	70,00	R 1 1/4'	4.3 kg
ZR40MA	150	188	65	75,00	R 1 1/2'	4.5 kg

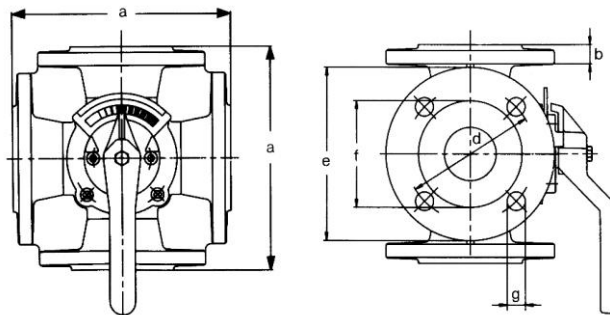

### With FLANGE connection

TYPE	a	b	e	g	h	Weight Net
ZR25FA	150	15	100	4 x 11	75	4.8 kg
ZR32FA	160	16	120	4 x 14	80	7.6 kg
ZR40FA	170	16	130	4 x 14	85	8.1 kg
ZR50FA	190	16	140	4 x 14	95	11.8 kg
ZR65FA	210	16	160	4 x 14	105	14.4 kg
ZR80FA	250	18	190	4 x 18	125	24.3 kg
ZR100FA	270	18	210	4 x 18	135	32.9 kg
ZR125FA	310	20	240	8 x 18	155	49.0 kg
ZR150FA	330	20	265	8 x 18	165	57.0 kg
ZR200FA	390	22	320	8 X 18	195	84.0 kg

### Servo motors for mixers VMK – VMM

**Application:**

Three-point control in heating and air handling applications.  
 Three-point control in (greenhouse) horticulture heating applications.

**Technical data:**

Protection class : IP 54 according to EN60529  
 Insulation class : II per EN60730  
 Control signal : Three-point (floating)  
 Rotation angle 90° : for DR-ZR and ZRK cranes  
 Rotation angle 120° : for DRK cranes

**Suitable faucets:**

DR-ZR series : VMM type  
 ZRK series : VMK-type

**Accessories:**

Switching, for installation  
 Contact load: 3 A, 230 V~  
 For servo motors VMK and VMM, 2 switches; VMS 2  
 For servo motors VRK and VRM, 1 switch; VRS 1

### Actuator for mixers DR/ZR (floating control)

Item no.	Description	Type	Nutrition	Duration	Price €
1800110	Servo motor	VMM 20-24	24 Vac	1.6 min.	477,00
1800153	Servo motor	VMM 20	230 Vac	1.6 min.	458,00
1800135	Servo motor	VMM 30-24	24 Vac	2.3 min.	577,00
1800174	Servo motor	VMM 30	230 Vac	2.3 min.	522,00
1800180	Servo motor	VMM 40-24	24 Vac	3.5 min.	582,00
1800181	Servo motor	VMM 40	230 Vac	3.5 min.	532,00
1800178	Servo motor	VMM 40-24F	24 Vac	1.2 min.	590,00
1800173	Servo motor	VMM 40F	230 Vac	1.2 min.	646,00



### Actuator for mixers DR/ZR (floating control)

Item no.	Description	Type	Nutrition	Duration	Price €
1800131	Servo motor	VMK 10-4-24	24 Vac	1.5 min.	379,00
1800114	Servo motor	VMK 10-4	230 Vac	1.5 min.	356,00
1800148	Servo motor	VRM 10N	24 Vac	2.0 min.	551,00
1800149	Servo motor	VRM 20N	24 Vac	2.0 min.	556,00
1800150	Servo motor	VRM 30N	24 Vac	2.0 min.	804,00
1800151	Servo motor	VRM 40N	24 Vac	2.0 min.	965,00
1800111	Servo motor	VRM 20	24 Vac	3.0 mins	556,00

### Engine parts

Item no.	Description	Type	Note	Price €
1800154	Auxiliary switch	VMS 2	for VMM	70,05
1800252	Clutch bushing		for VMM	36,10
1800184	Potentiometer set	VMP 10-90	10kohm-90°	89,50

<b>Three-way control valves PN 6 with flange connection</b>	
Three-way control valve with flange connection PN6	
Application: for modulating control of hot or cooling water in heating, ventilation and air treatment and horticultural applications.	
Technical data:	: flange connection ISO7005
Materials	: valve body cast iron GG25
Plug	: stainless steel
Water quality	: according to VDI2035
Characteristic A-AB	: equipercantage
Characteristic B-AB	: linear
Temperature V5329C	+ 2 ... 170°C
Temperature V5015A	+ 2 ... 130°C

<b>Three-way control valve PN6 with flange connection. Light height 20 mm</b>						
Item no.	Description	Type	Connection size	KVS value	Price €	
1900018	Mixing valve	XF15A4.0	DN 15	4	441,00	
1900017	Mixing valve	XF20A6.3	DN 20	6,3	441,00	
1900016	Mixing valve	XF25A10	DN 25	10	441,00	
1900014	Mixing valve	XF32A16	DN 32	16	476,00	
1900000	Mixing valve	XF40A25	DN 40	25	539,00	
1900001	Mixing valve	XF50A40	DN 50	40	589,00	
1900002	Mixing valve	XF65A63	DN 65	63	746,00	
1900003	Mixing valve	XF80A100	DN 80	100	921,00	

<b>Three-way control valve PN6 with flange connection. Light height 38 mm</b>					
Item no.	Description	Type	Connection size	KVS value	Price €
1900004	Mixing valve	XF100A140	DN 100	140	1.352,00
1900005	Mixing valve	XF125A220	DN 125	220	1.919,00
1900006	Mixing valve	XF150A310	DN 150	310	2.415,00

<b>Repair kit</b>				
Item no.	Description	Connection size	Note	Price €
1900008	Repair kit	DN 40-80	for XF 1-3"10MM	45,85
1900009	Repair kit	DN 100-150	for XF 4-6"12MM	65,50

<b>Servo motors with three-point control</b>					
Item no.	Type	Light height	Nutrition	Duration	Price €
1900034	ML6420A3007	20 mm	24 Vac	1.0 min.	528,00
1900035	ML6420A3015	20 mm	230 Vac	1.0 min.	536,00
1900013	ML6421A3005	20 mm	24 Vac	1.9 min.	721,00
1900010	ML6421B3004	38 mm	24 Vac	3.5 min.	721,00
1900011	ML6421B3012	38 mm	230 Vac	3.5 min.	721,00

<b>Servo motors with three-point control and spring return</b>					
Item no.	Type	Light height	Nutrition	Duration	Price €
1900040	ML6425B3005	20 mm	24 Vac	1.8 min.	1.221,00

<b>Limit switch</b>			
Item no.	Description	Note	Price €
1900042	Follow-up switch	for ML6420 / ML6425	240,00
1900030	Follow-up switch	for ML6421 / ML7421	262,00

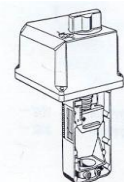

**ACCESSORIES FOR ZG CONTROLLERS**

<b>Outdoor temperature sensor</b>						
Measuring element		NTC20k				
Connection terminals		2				
Item no.	Description	Type	Temp. range	IP class	Price €	
1800076	Outdoor sensor	AF20-B54	- 40°C ... + 70°C	IP 54	51,75	



<b>Water temperature sensor (immersion tube)</b>						
Measuring element		NTC20k				
Measuring element		135mm				
Immersion tube		1/2" male thread				
Immersion tube		Copper				
Connection terminals		2				
Item no.	Description	Type	Temp. range	IP class	Price €	
1800104	Water sensor	VF20-1B54	0°C ... + 110°C	IP 52	65,50	



<b>Water temperature sensor (construction)</b>						
Measuring element		NTC20k				
Mounting location		Clamped on the main				
Connection terminals		2				
Item no.	Description	Type	Temp. range	IP class	Price €	
1800105	Water sensor	SF20-B54	0°C ... + 110°C	IP 52	51,10	



## CHAPTER 3

### *Circulation pumps*

*Johnson*

*Grundfos*



**JOHNSON COMBILINE PUMPS**

Johnson CombiLine built-in circulation pump with dry motor	
Technical data:	
Maximum capacity	: 400m <sup>3</sup> /h
Maximum head	: 1 - 28 m
Maximum temperature	: 140°C
Maximum working pressure	: 6 bar (ND 6 / flanges DIN2631 PN6)
	: 10 bar (ND10 / flanges DIN2633 PN16)
Rated speed	: 1450 min <sup>-1</sup> (4 pin)
Electric motor (at 50Hz)	: 1450/950 min <sup>-1</sup> (4-pin/6-pin)
IP class electric motor	: IP 55
Electric motor frequency	: 50 Hz 230/400 V (≤ 1.5 kW)
	400/695 V (≥ 2.2 kW)
<i>For other voltage and special voltage see Chapter 14 Appendix SPX pumps.</i>	

Johnson pumps type CL					
Item no.	Description	Engine power	Installation size	Nutrition	Price €
2010051	CL 32-125	0.13 kW	250	230/400 V	991,12
2010090	CL 40C-125 / PN6	0.13 kW	250	230/400 V	1.128,76
2010091	CL 40C-125 / PN6	0.18 kW	250	230/400 V	1.165,48
2010092	CL 40C-125 / PN6	0.25 kW	250	230/400 V	1.232,76
2010093	CL 40C-125 / PN6	0.37 kW	250	230/400 V	1.274,39
2010002	CL 40-160 / PN6	0.25 kW	320	230/400 V	1.365,84
2010003	CL 40-160 / PN6	0.37 kW	320	230/400 V	1.407,12
2010004	CL 40-160 / PN6	0.55 kW	320	230/400 V	1.443,83
2010005	CL 40-200 / PN6	0.55 kW	360	230/400 V	1.514,21
2010006	CL 40-200 / PN6	0.75 kW	360	230/400 V	1.560,07
2023015	CL 40-200 / PN6	1.10 kW	360	230/400 V	1.632,57
2010008	CL 50-125 / PN6	0.25 kW	280	230/400 V	1.420,91
2010009	CL 50-125 / PN6	0.37 kW	280	230/400 V	1.457,61
2010010	CL 50-160 / PN6	0.25 kW	340	230/400 V	1.546,00
2010011	CL 50-160 / PN6	0.37 kW	340	230/400 V	1.581,49
2010012	CL 50-160 / PN6	0.55 kW	340	230/400 V	1.636,55
2026015	CL 50-160 / PN6	0.75 kW	340	230/400 V	1.670,12
2010014	CL 50-200 / PN6	0.75 kW	380	230/400 V	1.792,53
2010015	CL 50-200 / PN6	1.10 kW	380	230/400 V	1.858,33
2026025	CL 50-200 / PN6	1.50 kW	380	230/400 V	1.925,01
2010017	CL 65-125 / PN6	0.25 kW	340	230/400 V	1.566,18
2010018	CL 65-125 / PN6	0.37 kW	340	230/400 V	1.596,78
2010019	CL 65-125 / PN6	0.55 kW	340	230/400 V	1.644,22
2010021	CL 65-160 / PN6	0.55 kW	340	230/400 V	1.800,21
2010022	CL 65-160 / PN6	0.75 kW	340	230/400 V	1.826,21
2010023	CL 65-160 / PN6	1.10 kW	340	230/400 V	1.899,64
2010024	CL 65-200 / PN16	1.10 kW	440	230/400 V	1.974,59
2010025	CL 65-200 / PN16	1.50 kW	440	230/400 V	2.041,87
2027024	CL 65-200 / PN16	2.20 kW	440	230/400 V	2.354,29
2010027	CL 80-125 / PN6	0.55 kW	360	230/400 V	1.745,13
2010028	CL 80-125 / PN6	0.75 kW	360	230/400 V	1.821,61
2010029	CL 80-125 / PN6	1.10 kW	360	230/400 V	1.904,22



Item no.	Description	Engine power	Installation size	Nutrition	Price €
2010030	CL 80-160 / PN6	1.10 kW	400	230/400 V	2.037,27
2010031	CL 80-160 / PN6	1.50 kW	400	230/400 V	2.089,29
2010032	CL 80-160 / PN6	2.20 kW	400	230/400 V	2.182,57
2010033	CL 80-200 / PN16	1.50 kW	530	230/400 V	2.349,31
2010034	CL 80-200 / PN16	2.20 kW	530	230/400 V	2.597,07
2010035	CL 80-200 / PN16	3.00 kW	530	230/400 V	2.724,04
2029024	CL 80A-250 / PN10	4.00 kW	590	230/400 V	4.940,23
2029029	CL 80A-250 / PN10	5.50 kW	590	230/400 V	5.452,63
2010500	CL 80A-250 / PN10	7.50 kW	590	230/400 V	5.818,18
2010501	CL 80A-250 / PN10	9.20 kW	590	230/400 V	6.348,88
2029003	CL 80A-250 / PN10	11.0 kW	590	230/400 V	6.598,20
2010036	CL 100-150 / PN6	0.75 kW	560	230/400 V	1.956,21
2010037	CL 100-150 / PN6	1.10 kW	560	230/400 V	2.083,16
2010038	CL 100-150 / PN6	1.50 kW	560	230/400 V	2.278,94
2010039	CL 100-160 / PN6	1.50 kW	560	230/400 V	2.575,67
2010040	CL 100-160 / PN6	2.20 kW	560	230/400 V	2.746,97
2010041	CL 100-160 / PN6	3.00 kW	560	230/400 V	2.858,63
2010048	CL 100-200 / PN6	2.20 kW	590	230/400 V	3.135,44
2010049	CL 100-200 / PN6	3.00 kW	590	230/400 V	3.335,85
2010050	CL 100-200 / PN6	4.00 kW	590	230/400 V	3.580,51
2013039	CL 100-200 / PN6	5.50 kW	590	230/400 V	4.481,41
2010056	CL 100-200 / PN6	7.50 kW	590	230/400 V	4.914,24
2014030	CL 100A-250 / PN10	5.50 kW	730	230/400 V	5.717,22
2010503	CL 100A-250 / PN10	7.50 kW	730	230/400 V	6.050,62
2014038	CL 100A-250 / PN10	9.20 kW	730	230/400 V	6.579,83
2014003	CL 100A-250 / PN10	11.0 kW	730	230/400 V	6.852,09
2010502	CL 100A-250 / PN10	15.0 kW	730	230/400 V	7.658,13
2010042	CL 125-160 / PN10	2.20 kW	750	230/400 V	3.634,04
2010043	CL 125-160 / PN10	3.00 kW	750	230/400 V	3.845,14
2010044	CL 125-160 / PN10	4.00 kW	750	230/400 V	4.100,55
2010508	CL 125-160 / PN10	5.50 kW	750	230/400 V	4.608,34
2015022	CL 125-160 / PN10	7.50 kW	750	230/400 V	5.002,96
2010509	CL 125C-200 / PN10	4.00 kW	750	230/400 V	4.245,86
2010058	CL 125C-200 / PN10	5.50 kW	750	230/400 V	4.755,18
2010059	CL 125C-200 / PN10	7.50 kW	750	230/400 V	5.148,25
2016027	CL 125A-250 / PN10	7.50 kW	805	230/400 V	6.662,42
2010505	CL 125A-250 / PN10	9.20 kW	805	230/400 V	7.220,70
2010504	CL 125A-250 / PN10	11.0 kW	805	230/400 V	7.486,83
2016001	CL 125A-250 / PN10	15.0 kW	805	230/400 V	8.360,17
2010060	CL 150-125 / PN10	2.20 kW	900	230/400 V	5.486,25
2018002	CL 150-125 / PN10	3.00 kW	900	230/400 V	5.698,88
2018004	CL 150-125 / PN10	4.00 kW	900	230/400 V	6.015,49
2010061	CL 150-160 / PN10	4.00 kW	750	230/400 V	5.998,65
2010063	CL 150-160 / PN10	5.50 kW	750	230/400 V	6.706,80
2018025	CL 150-160 / PN10	7.50 kW	750	230/400 V	7.145,76



Item no.	Description	Engine power	Installation size	Nutrition	Price €
2018052	CL 150-200 / PN10	4.00 kW	720	230/400 V	6.255,58
2010065	CL 150-200 / PN10	5.50 kW	720	230/400 V	6.963,77
2010066	CL 150-200 / PN10	7.50 kW	720	230/400 V	7.407,31
2010067	CL 150-200 / PN10	9.20 kW	720	230/400 V	7.964,04
2018067	CL 150-250 / PN10	11,00kW	900	230/400 V	8.617,13
2010068	CL 150-250 / PN10	15,00kW	900	230/400 V	9.254,91
2010077	CL 150-250 / PN10	18,50kW	900	230/400 V	10.201,66
2010069	CL 150-250 / PN10	22,00kW	900	230/400 V	10.626,85
2019021	CL 200-200 / PN10	9.20kW	900	230/400 V	7.968,59
2010072	CL 200-200 / PN10	11,00kW	900	230/400 V	8.234,75
2010073	CL 200-200 / PN10	15,00kW	900	230/400 V	9.126,44
2010074	CL 4/4 2-pole	0.26KW	1 PH	230V	825,91
2010052	CL 4/4 4-pole	0.13KW		230/400V	795,35
2010053	CL 4/4 2-pole	0.26KW		230/400V	825,93
2010054	CL 5/4 4-pole	0.13KW		230/400V	795,24
2010055	CL 5/4 2-pole	0.26KW		230/400V	825,93



For pumps with a special voltage see the appendix at the end of the price list.

**Frequency converters**

Drives Danfoss		
Item no.	Description	Price €
9993200	Frequency converter Danfoss FC-102P1K1	1.170,31
9993203	Frequency converter Danfoss FC-102P3K0	1.699,92
9993204	Frequency converter Danfoss FC-102P4K0	1.801,09
9993205	Frequency converter Danfoss FC-102P5K5	2.052,56
9993206	Frequency converter Danfoss FC-102P7K5	2.280,17
9993207	Frequency converter Danfoss FC-102P11K	2.903,93
9993208	Frequency converter Danfoss FC-102P15K	3.290,29
2130000	Differential pressure sensor DPI 0-0.6bar	621,00

**JOHNSON CombiBlocHorti PUMPS**

Johnson CombiBlocHorti centrifugal pumps				
Technical data:				
Maximum capacity	:	850m <sup>3</sup> /h		
Maximum head	:	105 m		
Maximum temperature	:	120°C		
Maximum working pressure	:	1000 kPa (10 bar)		
Maximum speed	:	3600 rpm		
<i>For other voltage and special voltage see Chapter 14 Appendix SPX pumps.</i>				

Item no.	Description	Engine power	Nutrition	Price €
2057007	CBH 80C-200	2.2 kW	230/400 V 3 phase, 50Hz, 4-p.	3.271,44
2057009	CBH 80C-200	3.0 kW	230/400 V 3 phase, 50Hz, 4-p.	3.438,90
2057012	CBH 80C-200	4.0 kW	230/400 V 3 phase, 50Hz, 4-p.	3.868,16
2057016	CBH 80C-200	5.5 kW	230/400 V 3 phase, 50Hz, 4-p.	4.028,04
2056009	CBH 80-250	3.0 kW	230/400 V 3 phase, 50Hz, 4-p.	3.702,25
2056014	CBH 80-250	4.0 kW	230/400 V 3 phase, 50Hz, 4-p.	4.133,06
2056016	CBH 80-250	5.5 kW	230/400 V 3 phase, 50Hz, 4-p.	4.292,90
2056020	CBH 80-250	7.5 kW	230/400 V 3 phase, 50Hz, 4-p.	4.892,67
2050007	CBH 100-160	2.2 kW	230/400 V 3 phase, 50Hz, 4-p.	3.434,34
2050009	CBH 100-160	3.0 kW	230/400 V 3 phase, 50Hz, 4-p.	3.601,76
2050013	CBH 100-160	4.0 kW	230/400 V 3 phase, 50Hz, 4-p.	4.032,57
2051012	CBH 100C-200	4.0 kW	230/400 V 3 phase, 50Hz, 4-p.	4.260,92
2051014	CBH 100C-200	5.5 kW	230/400 V 3 phase, 50Hz, 4-p.	4.586,71
2051017	CBH 100C-200	7.5 kW	230/400 V 3 phase, 50Hz, 4-p.	4.967,29
2051041	CBH 100C-250	4.0 kW	230/400 V 3 phase, 50Hz, 4-p.	4.534,95
2040499	CBH 100C-250	5.5 kW	230/400 V 3 phase, 50Hz, 4-p.	4.860,72
2040500	CBH 100C-250	7.5 kW	230/400 V 3 phase, 50Hz, 4-p.	5.153,00
2052026	CBH 125-250	7.5 kW	230/400 V 3 phase, 50Hz, 4-p.	5.679,71
2052000	CBH 125-250	11.0 kW	230/400 V 3 phase, 50Hz, 4-p.	6.373,90
2052001	CBH 125-250	15.0 kW	230/400 V 3 phase, 50Hz, 4-p.	7.100,02
2053000	CBH 150-125	2.2 kW	230/400 V 3 phase, 50Hz, 4-p.	4.618,67
2040501	CBH 150-125	3.0 kW	230/400 V 3 phase, 50Hz, 4-p.	4.653,70
2053003	CBH 150-125	4.0 kW	230/400 V 3 phase, 50Hz, 4-p.	5.105,82
2053016	CBH 150-160	4.0 kW	230/400 V 3 phase, 50Hz, 4-p.	5.381,35
2053018	CBH 150-160	5.5 kW	230/400 V 3 phase, 50Hz, 4-p.	5.716,26
2053020	CBH 150-160	7.5 kW	230/400 V 3 phase, 50Hz, 4-p.	6.086,19
2053039	CBH 150-200	4.0 kW	230/400 V 3 phase, 50Hz, 4-p.	5.615,79
2053041	CBH 150-200	5.5 kW	230/400 V 3 phase, 50Hz, 4-p.	5.929,38
2053044	CBH 150-200	7.5 kW	230/400 V 3 phase, 50Hz, 4-p.	6.303,87
2053048	CB 150-250	15 kW	230/400 V 3 phase, 50Hz, 4-p.	7.631,30

Item no.	Description	Engine power	Nutrition	Price €
2040502	CBH 200-200	11 kW	230/400 V 3 phase, 50Hz, 4-p.	6.999,54
2054001	CBH 200-200	15 kW	230/400 V 3 phase, 50Hz, 4-p.	7.750,05
2040503	CBH 250-200	11 kW	230/400 V 3 phase, 50Hz, 4-p.	7.617,62
2040504	CBH 250-200	15 kW	230/400 V 3 phase, 50Hz, 4-p.	7.996,65

For pumps with a special voltage see the appendix at the end of the price list.

**GRUNDFOS CIRCULATION PUMPS**

**Grundfos Built-in circulation pumps type MAGNA 1**

The GRUNDFOS MAGNA 1 circulation pump is designed for

Pumping liquids for:

Heating

Cooling

Domestic hot tap water

Geothermal heat pump systems.

The MAGNA 1 is the ideal replacement for the UPS.

Item no.	Description	Installation size	Nutrition	Price €
2110174	MAGNA 1 32-120F	220	1 x 230V	2.064,00
2110175	MAGNA 1 40-80F	220	1 x 230V	2.045,00
2110176	MAGNA 1 40-120F	250	1 x 230V	2.504,00
2110177	MAGNA 1 40-150F	250	1 x 230V	3.058,00
2110178	MAGNA 1 50-60F	240	1 x 230V	2.657,00
2110179	MAGNA 1 50-120F	280	1 x 230V	3.268,00
2110180	MAGNA 1 50-150F	280	1 x 230V	3.765,00
2110181	MAGNA 1 65-60F	340	1 x 230V	3.230,00
2110182	MAGNA 1 65-120F	340	1 x 230V	3.975,00
2110183	MAGNA 1 65-150F	340	1 x 230V	4.585,00
2110185	MAGNA 1 80-60F	360	1 x 230V	3.727,00
2110186	MAGNA 1 80-120F	360	1 x 230V	4.910,00



**Grundfos Concealed circulation pumps type MAGNA 3**

The MAGNA3 is suitable for both heating and cooling applications as well as for the circulation of household hot water systems.

The pump is designed to handle liquids down to -10 °C, making it suitable for both heavy industrial and industrial applications. tasks such as heat pump systems.

MAGNA3 has a built-in heat energy meter that provides system heat energy distribution and the consumption to avoid excessive energy bills due to system imbalances.

And it saves you the installation cost of a separate energy meter instrument.

Item no.	Description	Installation size	Nutrition	Price €
2115012	MAGNA 3 25-60	180	1 x 230V	1.306,00
2115015	MAGNA 3 25-80	180	1 x 230V	1.489,00
2115013	MAGNA 3 32-60	180	1 x 230V	1.581,00
2115016	MAGNA 3 32-80	180	1 x 230V	1.649,00
2110160	MAGNA 3 32-120F	220	1 x 230V	2.539,00
2115017	MAGNA 3 40-60F	220	1 x 230V	2.018,00
2110161	MAGNA 3 40-80F	220	1 x 230V	2.539,00
2110162	MAGNA 3 40-120F	250	1 x 230V	3.204,00
2110163	MAGNA 3 40-150F	250	1 x 230V	3.797,00
2110164	MAGNA 3 50-60F	240	1 x 230V	3.299,00
2110165	MAGNA 3 50-120F	280	1 x 230V	4.058,00
2110166	MAGNA 3 50-150F	280	1 x 230V	4.675,00
2110167	MAGNA 3 65-60F	340	1 x 230V	4.011,00
2110168	MAGNA 3 65-120F	340	1 x 230V	4.936,00
2110169	MAGNA 3 65-150F	340	1 x 230V	5.754,00
2110170	MAGNA 3 80-40F	360	1 x 230V	4.200,00
2110171	MAGNA 3 80-60F	360	1 x 230V	4.628,00
2110172	MAGNA 3 80-120F	360	1 x 230V	6.188,00
2110173	MAGNA 3 100-40	450	1 x 230V	5.183,00



GRUNDFOS CIRCULATION PUMPS TYPE TP (DRY VERSION)					
Scope of application: heating and cooling installations, tap water installations and industrial installations.					
Connections	: DN 25 – 100				
Max. system pressure	: 10 bar				
Media temperature	: - 15°C ... + 140°C				
Item no.	Description	Installation size	Connection	Engine power.	Price €
2110257	TP 32-60/4	280	DN 32	0.25 kW	1.180,00
2110230	TP 32-80/4	340	DN 32	0.25 kW	1.835,00
2110231	TP 32-100/4	340	DN 32	0.37 kW	1.871,00
2110232	TP 32-120/4	440	DN 32	0.55 kW	1.934,00
2110233	TP 32-320/2	340	DN 32	2.20 kW	2.301,00
2110234	TP 32-460/2	440	DN 32	4.00 kW	2.570,00
2110235	TP 32-580/2	440	DN 32	5.50 kW	3.181,00
2110200	TP 40-30	250	DN 40	0.12 kW	1.230,00
2110201	TP 40-60/4	250	DN 40	0.25 kW	1.398,00
2110236	TP 40-90/4	320	DN 40	0.25 kW	1.400,00
2110258	TP 40-100/4	340	DN 40	0.55 kW	2.105,00
2110300	TP 40-110/4	440	DN 40	0.75 kW	2.153,00
2110202	TP 40-120	250	DN 40	0.37 kW	1.452,00
2110238	TP 40-230/2	320	DN 40	1.10 kW	1.833,00
2110239	TP 40-270/2	320	DN 40	1.50 kW	2.001,00
2110301	TP 40-530/2	440	DN 40	7.70 kW	4.062,00
2110203	TP 50-30	280	DN 50	0.25 kW	1.420,00
2110204	TP 50-60/4	280	DN 50	0.37 kW	1.753,00
2110302	TP 50-80/4	440	DN 50	0.75 kW	2.506,00
2110205	TP 50-120	280	DN 50	0.75 kW	1.783,00
2110303	TP 50-120/4	440	DN 50	1.10 kW	2.550,00
2110304	TP 50-140/4	440	DN 50	1.50 kW	2.594,00
2110244	TP 50-290/2	340	DN 50	3.00 kW	2.618,00
2110245	TP 50-360/2	340	DN 50	4.00 kW	3.010,00
2110246	TP 50-430/2	340	DN 50	5.50 kW	3.984,00
2110206	TP 65-30	340	DN 65	0.25 kW	1.783,00
2110207	TP 65-60/4	340	DN 65	0.55 kW	2.138,00
2110256	TP 65-90/4	360	DN 65	0.75 kW	2.545,00
2110247	TP 65-110/4	475	DN 65	1.10 kW	2.643,00
2110208	TP 65-120	340	DN 65	1.10 kW	2.249,00
2110248	TP 65-130/4	475	DN 65	1.50 kW	2.790,00
2110249	TP 65-150/4	475	DN 65	2.20 kW	3.025,00
2110260	TP 65-170/4	475	DN 65	3.00 kW	3.157,00
2110310	TP 65-170/2	360	DN 65	2.2 kW	2.467,00
2110250	TP 65-180/2	340	DN 65	1.50 kW	2.448,00
2110311	TP 65-210/2	360	DN 65	3.00 kW	2.643,00
2110261	TP 65-240/4	475	DN 65	4.00 kW	3.626,00
2110253	TP 65-340/2	360	DN 65	5.50 kW	4.062,00
2110254	TP 65-460/2	475	DN 65	11.00 kW	6.039,00
2110255	TP 65-550/2	475	DN 65	15.00 kW	7.066,00
2110209	TP 80-30	360	DN 80	0.37 kW	2.405,00
2110210	TP 80-60/4 PN6	360	DN 80	0.75 kW	2.746,00
2110199	TP 80-60-60/4 PN10	360	DN 80	0.75 kW	2.746,00
2110263	TP 80-90/4	440	DN 80	1.50 kW	2.839,00
2110264	TP 80-110/4	440	DN 80	2.2 kW	3.083,00
2110211	TP 80-120	360	DN 80	1.50 kW	2.845,00
2110265	TP 80-150/4	500	DN 80	3.0 kW	3.230,00
2110266	TP 80-170/4	500	DN 80	4.0 kW	4.062,00
2110267	TP 100-70/4	500	DN 100	1.50 kW	3.649,00
2110268	TP 100-90/4	550	DN 100	2.20 kW	3.956,00



Grundfos circulation pumps type TP (dry version)					
Item no.	Description	Installation size	Connection	Engine power.	Price €
2110212	TP 100-30/4 PN6	450	DN 100	0.55 kW	3.095,00
2110223	TP 100-30/4 PN10	450	DN 100	0.55 kW	3.095,00
2110269	TP 100-110/4	550	DN 100	3.00 kW	4.213,00
2110330	TP 100-120/2	450	DN 100	2.20 kW	3.583,00
2110270	TP 100-130/4	550	DN 100	4.00 kW	4.728,00
2110271	TP 100-200/4	670	DN 100	7.50 kW	5.950,00
2110272	TP 125-60/6	620	DN 125	1.75 kW	4.597,00
2110273	TP 125-70/6	620	DN 125	2.20 kW	4.868,00
2110320	TP 125/80/6	800	DN 125	3.00 kW	5.679,00
2110321	TP 125-100/6	800	DN 125	4.00 kW	6.221,00
2110277	TP 125-130/4	620	DN 125	5.50 kW	5.517,00
2110322	TP 125-130/6	620	DN 125	5.50 kW	7.032,00
2110279	TP 125-160/4	620	DN 125	7.50 kW	7.302,00
2110281	TP 150-70/6	800	DN 150	3.00 kW	6.166,00
2110282	TP 150-90/6	800	DN 150	4.00 kW	6.762,00
2110283	TP 150-110/6	800	DN 150	5.50 kW	7.573,00
2110286	TP 150-200/4	800	DN 150	15.00 kW	9.779,00
2110287	TP 150-220/4	800	DN 150	18.50 kW	10.915,00

Grundfos circulation pumps ALPHA 1					
Supply voltage : 1 x 230 V – 50/60 Hz					
Flow rate, Qmax : 2.4 m <sup>3</sup> /hr					
Liquid temperature : +2° C to +110° C (TF 110)					
System pressure, Pmax : 1.0 MPa/10 bar					
Power : 5-45 W					
Ambient temperature : 0° C to +40° C EEI (avg): ≤ 0.21					
Protection class : IP 42					
Insulation class : F					
Item no.	Description	Installation size	Connection	Nutrition	Price €
2110190	ALPHA 1 GO 25-40	130		1 x 230V	464,00
2110191	ALPHA 1 GO 25-40	180		1 x 230V	371,00
2110192	ALPHA 1 GO 25-60	130		1 x 230V	534,00
2110193	ALPHA 1 GO 25-60	180		1 x 230V	427,00
2110194	ALPHA 1 GO 32-40	180		1 x 230V	511,00
2110195	ALPHA 1 GO 32-60	180		1 x 230V	470,00



GRUNDFOS UNILIFT STAINLESS STEEL SUBMERSIBLE PUMP TYPE KP					
Scope of application:					
Fluid transport and drainage, where the pump is fully or partially immersed in the liquid system.					
Suitable for clean, non-aggressive water and lightly polluted wastewater without faeces.					
Connection	1" female thread				
Dirt passage	10 mm				
Media temperature	+ 5°C ... + 50°C continuous (max. 70°C)				
Item no.	Description	Note	Nutrition	Price €	
2116000	Submersible pump KP 150-A1	Loose float	1 x 230 V	574,00	

## CHAPTER 4

*EBRO butterfly valves*

*Non-return valves*

*Valves*

*Welding throttling valves*

*Adjustment valves*



## EBRO BUTTERFLY VALVE, TYPE Z011-A

This universally applicable, high-quality and maintenance-free butterfly valve is suitable for both AC and CV applications.

The butterfly valve is suitable for mounting between counter flanges according to PN6/10/16.

Four centring ears ensure easy and secure installation.

Can be used as an end valve (max. 6 bar) with counter flanges PN 10.

### Material Specification:

Home	: GG 25 (alt.: GGG40)
	: Overall length acc. PN 6
	: Top flange acc. PN 6
Cuff	: EPDM with integrated flange gasket.
Valve disc	: up to DN 300 stainless steel
	from DN 350 steel (electro-nickel-plated)
Assen	: Stainless steel
Bearing	: Bronze, 3-fold
Operation	: 6° adjustable handle, incl. anti-fog bridge
	: Infinitely adjustable from DN 250
Max. differential pressure	: 10 bar
Max. temperature	: 130°C
	From DN300 onwards, no trade is included.

## EBRO Butterfly valve, type Z011-A

Item no.	Description	Type	Connection size	KVS value	Price €
2230000	Butterfly valve	Z011-A	DN 20	32	191,97
2230001	Butterfly valve	Z011-A	DN 25	36	77,73
2230002	Butterfly valve	Z011-A	DN32	40	77,73
2230003	Butterfly valve	Z011-A	DN 40	50	77,73
2230004	Butterfly valve	Z011-A	DN 50	85	77,06
2230005	Butterfly valve	Z011-A	DN 65	215	83,80
2230006	Butterfly valve	Z011-A	DN 80	420	120,04
2230007	Butterfly valve	Z011-A	DN 100	800	133,64
2230008	Butterfly valve	Z011-A	DN 125	1010	160,72
2230009	Butterfly valve	Z011-A	DN 150	2100	210,28
2230010	Butterfly valve	Z011-A	DN 200	4000	288,06
2230011	Butterfly valve	Z011-A	DN 250	6400	541,16
2230012	Butterfly valve	Z011-A	DN 300	8500	722,18
2230013	Butterfly valve excl. Lever	Z011-A	DN 350	11500	1.784,39
2230014	Butterfly valve excl. Lever	Z011-A	DN 400	14500	2.394,75
2230016	Butterfly valve excl. Lever	Z011-A	DN 500	21000	4.233,51
2230018	Butterfly valve excl. Lever	Z011-A	DN 600	29300	6.919,31



## EBRO Butterfly valve, type Z011-A including gearbox

Item no.	Description	Type	Connection size	KVS value	Price €
2231070	Butterfly valve incl. gear box	Z011-A	DN 200	4000	347,46
2231071	Butterfly valve incl. gear box	Z011-A	DN 250	6400	618,86
2231072	Butterfly valve incl. gear box	Z011-A	DN 300	8500	744,68
2231073	Butterfly valve incl. gear box	Z011-A	DN 350	11500	2.047,91
2231074	Butterfly valve incl. gear box	Z011-A	DN 400	14500	2.658,26

## Parts for butterfly valves

Item no.	Description	For passage	Price €
2230078	Lever	DN 20-65	29,27
2230079	Lever	DN 80-125	55,33
2230080	Lever	DN 150-200	84,61
2230081	Lever	DN 250-300	107,39

Worm gearboxes for butterfly valves			
Item no.	Description	For passage	Price €
2230082	Worm gear box	DN 150/200	118,06
2230083	Worm gear box	DN 250/300	156,46
2230017	Worm gear box	DN 350/400	263,52
2230019	Worm gear box	DN 450/500	520,37

### BUTTERFLY VALVE DIMENSIONS

For both type Z011-A for water and gas

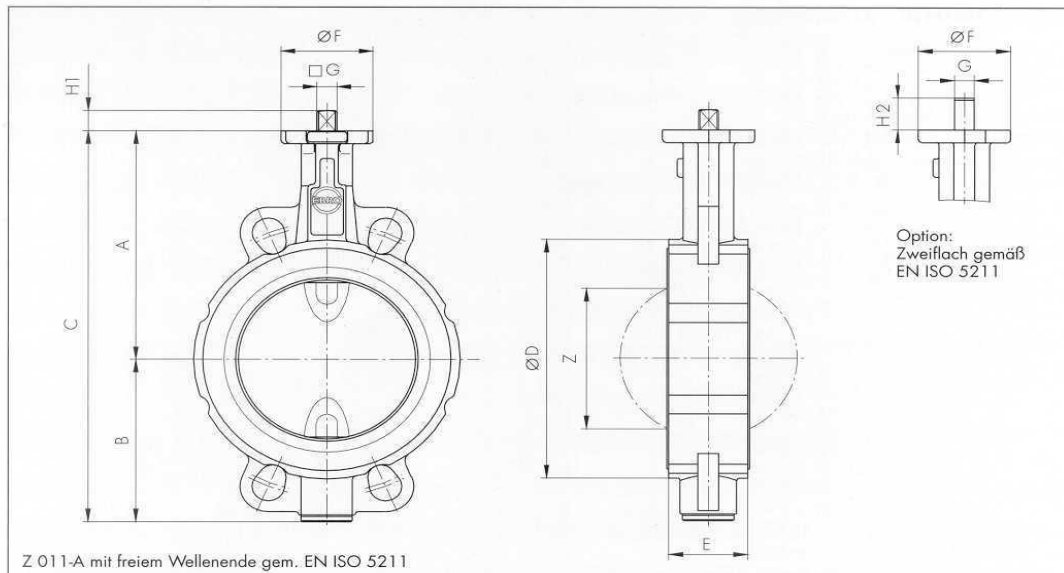

Passage DN	A	B	C	E	G
20	104	45	149	33,00	11
25	104	45	149	33,00	11
32	104	50	154	33,00	11
40	113	66	179	33,00	11
50	126	84	210	43,00	11
65	134	93	227	46,00	11
80	157	104	261	46,00	14
100	167	115	282	52,00	14
125	180	127	307	56,00	14
150	203	150	353	56,00	17
200	: 1 ... 5	176	404	60,00	17
250	266	212	478	68,00	22
300	291	237	528	78,00	22

## EBRO BUTTERFLY VALVE, TYPE Z011-A - GAS VERSION

This universally applicable, high-quality and maintenance-free butterfly valve is suitable for as a gas shut-off valve.

The butterfly valve is suitable for mounting between counter flanges according to PN6/10/16.

Four centring ears ensure easy and secure installation.

### Material Specification:

Home	: GG25 (alt.: GGG40)
	: Construction length according to DIN 3202 K1/ ISO 5752 short
	: Top flange according to ISO 5211
Cuff	: PERBUNAN with integrated flange gasket
	easily interchangeable
Valve	: up to DN 300 stainless steel stainless steel 316
Assen	: Stainless steel
Bearing	: Bronze, 3-fold
Operation	: 6° adjustable handle, incl. anti-condensation bridge
	infinitely adjustable from DN 250
Max. differential pressure	: 10 bar (also 16 bar available)
Max. temperature	: 130°C

From DN300 onwards, no handle is included.

## EBRO Butterfly valve type Z011-A GAS without approval

Item no.	Description	Type	Connection size	Price €
2230020	Butterfly valve	Z011-A GAS	DN 20	90,17
2230021	Butterfly valve	Z011-A GAS	DN 25	90,17
2230022	Butterfly valve	Z011-A GAS	DN 32	90,17
2230023	Butterfly valve	Z011-A GAS	DN 40	96,74
2230024	Butterfly valve	Z011-A GAS	DN 50	120,71
2230025	Butterfly valve	Z011-A GAS	DN 65	133,97
2230026	Butterfly valve	Z011-A GAS	DN 80	167,14
2230027	Butterfly valve	Z011-A GAS	DN 100	199,14
2230028	Butterfly valve	Z011-A GAS	DN 125	252,08
2230029	Butterfly valve	Z011-A GAS	DN 150	325,02
2230030	Butterfly valve	Z011-A GAS	DN 200	414,00
2230031	Butterfly valve	Z011-A GAS	DN 250	890,59
2230032	Butterfly valve	Z011-A GAS	DN 300	951,45



## EBRO Butterfly valve type Z011-A GAS Yellow – certified according to DVGW approval

Item no.	Description	Type	Connection size	Price €
2230033	Butterfly valve	Z011-A GAS YELLOW	DN 40	177,03
2230034	Butterfly valve	Z011-A GAS YELLOW	DN 50	191,86
2230035	Butterfly valve	Z011-A GAS YELLOW	DN 65	208,15
2230036	Butterfly valve	Z011-A GAS YELLOW	DN 80	232,04
2230037	Butterfly valve	Z011-A GAS YELLOW	DN 100	248,33
2230038	Butterfly valve	Z011-A GAS YELLOW	DN 125	298,96
2230039	Butterfly valve	Z011-A GAS YELLOW	DN 150	386,71
2230058	Butterfly valve	Z011-A GAS YELLOW	DN 200	510,47



EBRO BUTTERFLY VALVES WITH EBRO SERVO MOTORS				
Controls:		: electric drive E65/E110 type WS		
Voltage:		: 230V – 50Hz and equipped with two extra end contacts for open and close feedback.		
Standard Term		: Type E65 6 seconds : Type E110 12 seconds		
Item no.	Description	Connection size	KVS value	Price €
2230040	Butterfly valve with E-65 engine	DN 20	32	1.026,23
2230041	Butterfly valve with E-65 engine	DN 25	36	941,37
2230042	Butterfly valve with E-65 engine	DN 32	40	941,37
2230043	Butterfly valve with E-65 engine	DN 40	50	941,37
2230044	Butterfly valve with E-65 engine	DN 50	85	946,55
2230045	Butterfly valve with E-65 engine	DN 65	215	952,12
2230046	Butterfly valve with E-65 engine	DN 80	420	977,52
2230047	Butterfly valve with E-65 engine	DN 100	800	988,67
2230048	Butterfly valve with E-65 engine	DN 125	1010	1.010,86
2230049	Butterfly valve with E-110 engine	DN 150	2100	1.560,46
2230050	Butterfly valve with E-110 engine	DN 200	4000	1.624,96
2230051	Butterfly valve with E-110 engine	DN 250	6400	1.857,96
2230052	Butterfly valve with E-110 engine	DN 300	8500	1.983,76
2230053	Butterfly valve with E-160 engine	DN 350	11500	4.350,17
2230054	Butterfly valve with motor 400V	DN 400	14500	4.760,58
2230056	Butterfly valve with motor 400V	DN 500	20500	7.914,80



EBRO SERVO MOTORS					
<p>Ebro has its own range of electric drives, which are distinguished by Compact design and high operational reliability.</p> <p>The user-friendly wiring, via a central plug connection in the lid as well as an interchangeable coupling shaft, simplify assembly and connection.</p> <p>Both types are equipped with a thermal protection against overheating.</p> <p>The electric drive is equipped with a handwheel for emergency operation.</p> <p>The type E100 is also equipped with a torque switch.</p> <p>Technical specification:</p> <p>Operation : EBRO electric drive E65/E110</p> <p>Protection class : IP 65</p> <p>Adjusting power : Type E65 ; 100 Nm : Type E110 ; 400 Nm</p> <p>Other voltages and durations on request.</p>					
Item no.	Description	Type	Tension	Duration	Price €
2230060	EBRO Servo Motor	E65WS	230 Vac	6 sec.	887,79
2230061	EBRO Servo Motor	E110WS	230 Vac	12 sec.	1.395,56
2230067	EBRO Servo Motor	E160Ws	230 Vac	24 sec.	2.565,78



Pneumatic actuators				
Item no.	Description	Type	For passage	Price €
2230100	Pneumatic	EB 4	DN 20-65	274,35
2230101	Pneumatic	EB 5	DN 80-125	377,21
2230105	Pneumatic	EB 6	DN 150-200	437,86
2230102	Pneumatic	EB 8	DN 150-200	529,55
2230103	Pneumatic	EB 10	DN 250-300	950,66
2230104	Pneumatic	EB 12	DN 350-400	1.247,33
2230108	Drosselblok for pneumatic			104,37
2230110	Herion air valve	5/2 24VAC		166,28



### EBRO BUTTERFLY VALVE, TYPE Z014-A Lugtype

Material Specification:

Home	: Cast iron GGG40
Construction length	: EN 558 series 20 (DIN 3202 T3 K1)
Cuff	: EPDM - HT
Valve	: Stainless steel SS316
Assen	: Stainless steel
Flange connection	: PN 10
P-max	: 10 bar
Temperature	: t-max 120°C
Operation	: aluminum lever

### EBRO Butterfly valve, type Z011-A

Item no.	Description	Type	Connection size	Price €
2230120	Butterfly valve	Z014-A	DN 32	163,41
2230121	Butterfly valve	Z014-A	DN 40	163,41
2230122	Butterfly valve	Z014-A	DN 50	163,41
2230123	Butterfly valve	Z014-A	DN 65	182,62
2230124	Butterfly valve	Z014-A	DN 80	239,18
2230125	Butterfly valve	Z014-A	DN 100	275,58
2230126	Butterfly valve	Z014-A	DN 125	352,41
2230127	Butterfly valve	Z014-A	DN 150	457,10
2230128	Butterfly valve	Z014-A	DN 200	648,34



### EBRO CHECK VALVES RSK – TYPE CP-2/316

Compact non-return valve for general applications and to prevent unwanted flow directions. The eccentric valve suspension results in a positive seal. O-ring seal on both sides for flange sealing.

Technical specifications:

Home : Steel  
 Valve : Stainless steel stainless steel 316  
 Seat : EPDM  
 Assembly : between PN10/PN16 flanges.

Item no.	Description	Type	Connection size	Price €
2240000	Non-return valve	CP-2/316	DN 40	88,94
2240001	Non-return valve	CP-2/316	DN 50	91,16
2240002	Non-return valve	CP-2/316	DN 65	93,98
2240003	Non-return valve	CP-2/316	DN 80	99,67
2240004	Non-return valve	CP-2/316	DN 100	128,08
2240005	Non-return valve	CP-2/316	DN 125	150,93
2240006	Non-return valve	CP-2/316	DN 150	219,26
2240007	Non-return valve	CP-2/316	DN 200	344,59
2240008	Non-return valve	CP-2/316	DN 250	549,63
2240009	Non-return valve	CP-2/316	DN 300	899,91



### EBRO CHECK VALVES – DUO CHECK (DC)

Duo-check check valve with two-piece spring-loaded stainless steel valves.

Construction length according to ISO 5752 long, DIN 3202 K3.

Mounting between flanges PN 10/16. Robust construction and compact installation.

Technical specifications:

Home : Ductile iron GGG 40  
 Valves : Stainless steel stainless steel 316  
 Assen : Stainless steel stainless steel 316  
 Rings : PTFE  
 Springs : stainless steel 302  
 Seat : EPDM

Item no.	Description	Type	Connection size	Price €
2240041	Non-return valve	DUO CHECK	DN 50	70,98
2240042	Non-return valve	DUO CHECK	DN 65	80,71
2240043	Non-return valve	DUO CHECK	DN 80	113,02
2240044	Non-return valve	DUO CHECK	DN 100	148,51
2240045	Non-return valve	DUO CHECK	DN 125	179,82
2240046	Non-return valve	DUO CHECK	DN 150	253,49
2240047	Non-return valve	DUO CHECK	DN 200	394,38
2240048	Non-return valve	DUO CHECK	DN 250	610,16
2240049	Non-return valve	DUO CHECK	DN 300	837,10



<b>Cast iron gate valve PN 6, type 2215</b>					
Cast iron gate valve according to DIN3352.					
House and top	: Cast iron GG25				
Spindle material	: 13% Chromium steel				
Grommets	: Brass				
Other passages available on request.					
Item no.	Description	Connection size	Installation length	Pressure	Price €
2202003	Gate valve	65 mm	170 mm	PN 6	178,39
2202005	Gate valve	100 mm	190 mm	PN 6	259,60
2202007	Gate valve	150 mm	210 mm	PN 6	433,84



<b>Cast iron gate valve PN 10, type 2200</b>					
Cast iron gate valve.					
Technical specifications:					
House and top	: Cast iron GG25				
Spindle material	: 13% Chromium steel				
Grommets	: Bronze				
Other passages available on request.					
Item no.	Description	Connection size	Installation length	Pressure	Price €
2202010	Gate valve	50 mm	150 mm	10/16 Bar	163,76
2202011	Gate valve	65 mm	170 mm	10/16 Bar	203,79
2202012	Gate valve	80 mm	180 mm	10/16 Bar	236,16
2202013	Gate valve	100 mm	190 mm	10/16 Bar	297,16
2202014	Gate valve	125 mm	200 mm	10/16 Bar	396,06
2202015	Gate valve	150 mm	210 mm	10/16 Bar	484,13
2202016	Gate valve	200 mm	230 mm	10/16 Bar	771,90



<b>Brass gate valves</b>					
Brass gate valves, full bore with aluminum lever.					
Technical specifications:					
Max. pressure	: 16 bar				
Max. temperature	: max. 100 °C				
Wire	: Female thread				
Item no.	Description	Type	Connection size		Price €
2204013	Closing	175 GLO	1/2"		7,91
2204014	Closing	175 GLO	3/4"		12,08
2204015	Closing	175 GLO	1"		15,01
2204016	Closing	175 GLO	1 1/4"		24,40
2204017	Closing	175 GLO	1 1/2"		32,85
2204018	Closing	175 GLO	2"		47,35
2204019	Closing	175 GLO	2 1/2"		80,43
2204020	Closing	175 GLO	3"		107,88



**GATE VALVE ROT-GELB**

**Gate Valve Rot-Gelb**

Usage features:

Steam up to + 160°C.

Mineral oils and fats up to + 160°C.

Petrol, air.

For a working pressure of up to 20 bar.

Cold water.

Hot water up to 160°C.

Item no.	Description	Connection	Price €
2203001	Valve bronze Rot-gelb	3/8"	21,63
2203002	Valve bronze Rot-gelb	1/2"	25,33
2203003	Valve bronze Rot-gelb	3/4"	35,81
2203004	Valve bronze Rot-gelb	1"	42,92
2203005	Valve bronze Rot-gelb	1 1/4"	61,48
2203006	Valve bronze Rot-gelb	1 1/2"	85,39
2203007	Valve bronze Rot-gelb	2"	129,68
2203008	Valve bronze Rot-gelb	2 1/2"	226,16
2203009	Valve bronze Rot-gelb	3"	307,28



**CHECK VALVES**

**Bronze Check Valves Rot-Gelb**

For water, saturated and wet steam, mineral-containing oils, fats and air.

Equipped with sloping seat and bronze seal ND 16.

Technical data:

Maximum temperature : 160°C.



Working pressure : 16 bar

Equipped with sloping seat and bronze seal ND 16.

Item no.	Description	Connection size	Price €
2203017	Non-return valve	3/8"	20,21
2203010	Non-return valve	1/2"	28,23
2203011	Non-return valve	3/4"	37,97
2203012	Non-return valve	1"	57,21
2203013	Non-return valve	1 1/4"	69,39
2203014	Non-return valve	1 1/2"	92,50
2203016	Non-return valve	2"	127,34



FALL ARREST CHECK VALVES (SPRING LOADED)						
Item no.	Description	Type	Connection size	Note	Price €	
2203020	Non-return valve		1/2"		10,33	
2203021	Non-return valve		3/4"		16,06	
2203022	Non-return valve		1"		22,58	
2203023	Non-return valve		1 1/4"		36,39	
2203024	Non-return valve		1 1/2"		58,87	
2203025	Non-return valve		2"		97,37	
2203028	Suction strainer	Fall arrest	1/2"	Stainless steel	2,17	
2203029	Suction strainer	Fall arrest	3/4"	Stainless steel	2,48	
2203030	Suction strainer	Fall arrest	1"	Stainless steel	2,79	
2203031	Suction strainer	Fall arrest	1 1/4"	Stainless steel	3,50	
2203032	Suction strainer	Fall arrest	1 1/2"	Stainless steel	3,95	
2203033	Suction strainer	Fall arrest	2"	Stainless steel	6,23	

<b>Ball valves</b>											
Full bore ball valves, equipped with handle.											
Applications include water, oil, vapors, air and gasoline.											
Material housing	: brass MS 58, then nickel-plated.										
Ball material	: brass MS 58, then chrome-plated.										
Pressure	: PN 30.										
Temperature	: - 20°C ... + 180°C										
Seals	: P.T.F.E. (Teflon)										
<b>Ball valves BI / BI thread</b>											
Item no.	Description	Connection size	Connection		Price €						
2205000	Ball valve	1/4"	bi/bi		4,39						
2205001	Ball valve	3/8"	bi/bi		4,62						
2205002	Ball valve	1/2"	bi/bi		5,62						
2205003	Ball valve	3/4"	bi/bi		8,20						
2205004	Ball valve	1"	bi/bi		12,93						
2205005	Ball valve	1 1/4"	bi/bi		19,91						
2205006	Ball valve	1 1/2"	bi/bi		28,86						
2205007	Ball valve	2"	bi/bi		47,39						
2205008	Ball valve	2 1/2"	bi/bi		110,11						
2205009	Ball valve	3"	bi/bi		171,41						
2205010	Ball valve	4"	bi/bi		279,94						
											
						<b>Ball valves BI / BU thread</b>					
						Item no.	Description	Connection size	Connection		Price €
						2205068	Ball valve	3/8"	BI/BU		5,21
						2205059	Ball valve	1/4"	BI/BU		4,94
						2205060	Ball valve	1/2"	BI/BU		6,14
						2205061	Ball valve	3/4"	BI/BU		9,00
						2205062	Ball valve	1"	BI/BU		13,95
						2205063	Ball valve	1 1/4"	BI/BU		22,49
						2205064	Ball valve	1 1/2"	BI/BU		32,71
											
						<b>Ball valves compression fitting</b>					
						Item no.	Description	Connection size	Connection		Price €
						2205070	Ball valve	15 mm	Squeeze		12,06
2205071	Ball valve	22 mm	Squeeze		18,89						
2205072	Ball valve	28 mm	Squeeze		20,80						
<b>Ball valves BI / BI wire with wing handle</b>											
Item no.	Description	Connection size	Connection	Note	Price €						
2205083	Ball valve	1/2"	bi/bi	Wing	6,01						
2205084	Ball valve	3/4"	bi/bi	Wing	7,68						
2205085	Ball valve	3/8"	bi/bi	Wing	4,93						
2205088	Ball valve	1"	bi/bi	Wing	13,73						
											
						<b>Ball valves with motor 24 V + 220 V</b>					
						Item no.	Description	Connection size	Nutrition		Price €
						2205050	Ball valve	1/2"	24 V		171,85
2205051	Ball valve	3/4"	24 V		191,07						
2205052	Ball valve	1"	24 V		229,33						
2205053	Ball valve	1 1/4"	24 V		263,58						
2205054	Ball valve	1 1/2"	24 V		323,77						
2205055	Ball valve	1/2"	220 V		171,85						
2205056	Ball valve	3/4"	220 V		191,07						
2205057	Ball valve	1"	220 V		229,33						
2205058	Ball valve	1 1/4"	220 V		263,58						
2205065	Ball valve	1 1/2"	220 V		323,77						
2205066	Separate motor		24 Vac		121,63						
2205067	Separate motor		220 Vac		121,63						

<b>Gas ball valve with GIVEG and GASTEC QA approval</b>				
Gas ball valve with coupling. Equipped with GIVEG and Gastec QA mark.				
Technical data:				
Clutch			: External thread	
Suitable for printing			: up to 200 mbar.	
Item no.	Description	Connection size	Connection	Price €
5200002	Gas ball valve	1/2"	BI/BU	11,67
5200003	Gas ball valve	3/4"	BI/BU	17,29
5200004	Gas ball valve	1"	BI/BU	31,33
5200005	Gas ball valve	1 1/4"	BI/BU	183,35
5200006	Gas ball valve	1 1/2"	BI/BU	229,37
5200007	Gas ball valve	2"	BI/BU	382,68



<b>Gas ball valve with DVGW approval</b>				
Gas ball valve with internal thread. Equipped with DVGW approval.				
Item no.	Description	Connection size	Connection	Price €
5200031	Gas ball valve	1/4"	Female thread	3,46
5200029	Gas ball valve	3/8"	Female thread	3,68
5200025	Gas ball valve	1/2"	Female thread	7,39
5200026	Gas ball valve	3/4"	Female thread	10,16
5200023	Gas ball valve	1"	Female thread	15,29
5200024	Gas ball valve	1 1/4"	Female thread	25,47
5200021	Gas ball valve	1 1/2"	Female thread	40,07
5200022	Gas ball valve	2"	Female thread	56,43



## LUCIFER SOLENOID VALVES

<b>Solenoid valve for water and steam. Closed without electricity.</b>				
Technical data:				
Gas and oil medium temperature			: max. + 100°C	
Medium temperature flea fabrics			: max. + 75°C	
Connection			: female thread	
Valve body			: press brass.	
Interior			: stainless steel and brass.	
Seals			: NBR	
Item no.	Description	Connection size	Type	Price €
2208003	Mangeet valve	1/2"	221G15	169,70
2208004	Solenoid valve	3/4"	221G16	206,87
2208005	Solenoid valve	1"	221G17	237,04
2208006	Solenoid valve	1 1/4"	E321G38	741,14
2208007	Solenoid valve coil	230V-50Hz		58,45
2208013	Solenoid valve coil	24V-50Hz		58,45
2208008	Solenoid valve coil	24V DC		58,45



**ADJUSTMENT VALVES**

**Adjustment valves with measuring nipples**

Flanged adjustment valves for adjusting heating valves and refrigeration installations (ethylene glycol and brine), not suitable for drinking water systems.

Features : adjusting, shutting off and measuring differential pressure and flow rate.  
 Flanges Ordinary: PN16  
 Max. working pressure : 16 bar  
 Max. working temperature : - 120°C  
 Min. Working Temperature : - 10°C  
 Material : cast iron (GG25)

Item no.	Description	Type	Connection size	Note	Price €
2250000	Adjustment valve	STAFF	DN 20		377,89
2250001	Adjustment valve	STAFF	DN 25		415,50
2250002	Adjustment valve	STAFF	DN 32		482,57
2250003	Adjustment valve	STAFF	DN 40		582,37
2250004	Adjustment valve	STAFF	DN 50		623,26
2250005	Adjustment valve	STAFF	DN 65		744,32
2250006	Adjustment valve	STAFF	DN 80		1.241,62
2250007	Adjustment valve	STAFF	DN 100		1.845,25
2250008	Adjustment valve	STAFF	DN 125		2.514,33
2250009	Adjustment valve	STAFF	DN 150		3.765,79
2250010	Adjustment valve	STAFF	DN 200		6.492,77
2250011	Adjustment valve	STAFF	DN 250		9.980,42
2250012	Adjustment valve	STAFF	DN 300		21.119,06
2250016	Measuring nipple		1/4"	3 cm	20,61



## CHAPTER 5

*Malleable fittings*

*Mounting materials*

*Central heating pipe*



**MALLEABLE FITTINGS BLACK**

Item no.	Description	Type	Connection size	Price €
2300002	Bend black	No. 1	1/4	4,49
2300003	Bend black	No. 1	3/8	5,37
2300004	Bend black	No. 1	1/2	4,82
2300005	Bend black	No. 1	3/4	8,36
2300006	Bend black	No. 1	1	11,27
2300007	Bend black	No. 1	1 1/4	19,84
2300008	Bend black	No. 1	1 1/2	25,56
2300009	Bend black	No. 1	2	42,35
2300012	Bend black	No. 2	1/4	4,86
2300013	Bend black	No. 2	3/8	5,18
2300014	Bend black	No. 2	1/2	5,48
2300015	Bend black	No. 2	3/4	8,59
2300016	Bend black	No. 2	1	11,27
2300017	Bend black	No. 2	1 1/4	19,93
2300018	Bend black	No. 2	1 1/2	24,56
2300019	Bend black	No. 2	2	33,85
2300022	Bend black	No. 40	1/2	5,48
2300023	Bend black	No. 40	3/4	7,42
2300021	Bend black	No. 40	2	34,14
2300024	Bend black	No. 41	1/2	6,67
2300025	Bend black	No. 41	3/4	8,23



Item no.	Description	Type	Connection size	Price €
2300034	Knee black	No. 90	3/8	2,44
2300033	Knee black	No. 90	1/4	3,00
2300035	Knee black	No. 90	1/2	1,58
2300036	Knee black	No. 90	3/4	2,54
2300037	Knee black	No. 90	1	3,91
2300038	Knee black	No. 90	1 1/4	7,69
2300039	Knee black	No. 90	1 1/2	12,36
2300040	Knee black	No. 90	2	14,28
2300041	Knee black	No. 90	2 1/2	41,76
2300026	Knee black	No. 90	3	58,13
2300042	Knee black	No. 90	3/4X1/2	3,91
2300043	Knee black	No. 90	1X1/2	5,18
2300044	Knee black	No. 90	1X3/4	5,69
2300046	Knee black	No. 92	3/8	3,00
2300045	Knee black	No. 92	1/4	3,10
2300047	Knee black	No. 92	1/2	2,04
2300048	Knee black	No. 92	3/4	3,16
2300050	Knee black	No. 92	1 1/4	9,15
2300051	Knee black	No. 92	1 1/2	13,35
2300052	Knee black	No. 92	2	17,39
2300053	Knee black	No. 92	2 1/2	43,84





Item no.	Description	Type	Connection size	Price €
2300056	Knee coupling black	No. 96	3/8	15,85
2300057	Knee coupling black	No. 96	1/2	11,62
2300058	Knee coupling black	No. 96	3/4	13,43
2300059	Knee coupling black	No. 96	1	19,39
2300060	Knee coupling black	No. 96	1 1/4	32,64
2300061	Knee coupling black	No. 96	1 1/2	38,22
2300062	Knee coupling black	No. 96	2	64,40
2300063	Knee coupling black	No. 96	2 1/2	137,87
2300064	Knee coupling black	No. 98	3/8	14,25
2300065	Knee coupling black	No. 98	1/2	11,66
2300066	Knee coupling black	No. 98	3/4	14,90
2300067	Knee coupling black	No. 98	1	20,38
2300068	Knee coupling black	No. 98	1 1/4	33,76
2300069	Knee coupling black	No. 98	1 1/2	42,26
2300070	Knee coupling black	No. 98	2	68,62



Item no.	Description	Type	Connection size	Price €
2300071	T-piece black	No. 130	1/4	4,08
2300072	T-piece black	No. 130	3/8	3,62
2300073	T-piece black	No. 130	1/2	2,31
2300074	T-piece black	No. 130	3/4	3,94
2300075	T-piece black	No. 130	1	5,73
2300076	T-piece black	No. 130	1 1/4	10,46
2300077	T-piece black	No. 130	1 1/2	16,03
2300078	T-piece black	No. 130	2	23,01
2300079	T-piece black	No. 130	2 1/2	51,77
2300080	T-piece black	No. 130	1/2x3/4	5,16
2300082	T-piece black	No. 130	3/4x1/2	4,23
2300083	T-piece black	No. 130	3/4x1	10,50
2300084	T-piece black	No. 130	1x1/2	5,58
2300085	T-piece black	No. 130	1x3/4	6,10
2300086	T-piece black	No. 130	1 1/4x1/2	9,19
2300087	T-piece black	No. 130	1 1/4x3/4	9,99
2300303	T-piece black	No. 130	1 1/2x1	14,53
2300091	T-piece black	No. 130	3/4x1/2x1/2	4,62
2300092	T-piece black	No. 130	3/4x3/4x1/2	5,37
2300098	T-piece black	No. 130	1x3/4x3/4	6,91
2300099	T-piece black	No. 130	1x1x1/2	7,29
2300100	T-piece black	No. 130	1x1x3/4	7,96
2300304	T-piece black	No. 130	1 1/4x1x1 1/4	10,99
2300306	T-piece black	No. 130	2x1 1/2x2	27,64
2300300	T-piece black	No. 130	1 1/2x3/4x1 1/2	13,34
2300095	T-piece black	No. 130	2x1/2x2	18,12
2300301	T-piece black	No. 130	2x3/4x2	23,56
2300305	T-piece black	No. 130	2x1x2	18,57



Item no.	Description	Type	Connection size	Price €	
2300101	Cross piece black	No. 180	3/8	8,36	 <p>NR: 180</p>
2300102	Cross piece black	No. 180	1/2	8,23	
2300103	Cross piece black	No. 180	3/4	12,57	
2300104	Cross piece black	No. 180	1	15,35	

Item no.	Description	Type	Connection size	prijs €	
2300106	Reducer sock black	No. 240	3/8X1/4	3,33	 <p>NR: 240</p>
2300107	Reducer sock black	No. 240	1/2X1/4	3,54	
2300108	Reducer sock black	No. 240	1/2X3/8	3,16	
2300109	Reducer sock black	No. 240	3/4X3/8	4,08	
2300110	Reducer sock black	No. 240	3/4X1/2	3,38	
2300111	Reducer sock black	No. 240	1X1/2	4,40	
2300112	Reducer sock black	No. 240	1X3/4	3,94	
2300113	Reducer sock black	No. 240	11/4X1/2	8,05	
2300114	Reducer sock black	No. 240	11/4X3/4	7,27	
2300115	Reducer sock black	No. 240	11/4X1	7,18	
2300117	Reducer sock black	No. 240	11/2X3/4	11,27	
2300118	Reducer sock black	No. 240	11/2X1	8,72	
2300119	Reducer sock black	No. 240	11/2X11/4 XXXX	9,46	
2300120	Reducer sock black	No. 240	1X3/8	5,69	
2300122	Reducer sock black	No. 240	2X1	16,76	
2300123	Reducer sock black	No. 240	2X11/4	15,03	
2300124	Reducer sock black	No. 240	2X11/2	14,25	

Item no.	Description	Type	Connection size	Price €	
2300127	Reducer ring black	No. 241	3/8X1/4	2,19	 <p>NR: 241</p>
2300126	Reducer ring black	No. 241	1/4X1/8	3,04	
2300128	Reducer ring black	No. 241	1/2X1/4	1,79	
2300129	Reducer ring black	No. 241	1/2X3/8	1,64	
2300131	Reducer ring black	No. 241	3/4X1/4	3,40	
2300132	Reducer ring black	No. 241	3/4X3/8	2,51	
2300133	Reducer ring black	No. 241	3/4X1/2	1,72	
2300136	Reducer ring black	No. 241	1X1/2	2,54	
2300137	Reducer ring black	No. 241	1X3/4	2,31	
2300138	Reducer ring black	No. 241	1X3/8	4,08	
2300139	Reducer ring black	No. 241	11/4X1/2	4,72	
2300140	Reducer ring black	No. 241	11/4X3/4	4,05	
2300141	Reducer ring black	No. 241	11/4X1	3,04	
2300142	Reducer ring black	No. 241	11/2X1/2	5,77	
2300143	Reducer ring black	No. 241	11/2X3/4	6,67	
2300144	Reducer ring black	No. 241	11/2X1	4,40	
2300145	Reducer ring black	No. 241	11/2X11/4 XXXX	4,49	
2300146	Reducer ring black	No. 241	2X1/2	11,71	
2300147	Reducer ring black	No. 241	2X3/4	11,62	
2300148	Reducer ring black	No. 241	2X1	9,55	
2300149	Reducer ring black	No. 241	2X11/4	9,11	
2300150	Reducer ring black	No. 241	2X11/2	8,16	
2300151	Reducer ring black	No. 241	21/2X1	18,98	
2300153	Reducer ring black	No. 241	21/2X2	15,67	

Item no.	Description	Type	Connection size	Price €
2300168	Adapter nipple black	No. 245	3/8X1/4	3,38
2300155	Adapter nipple black	No. 245	1/2X1/4	4,72
2300154	Adapter nipple black	No. 245	1/2X3/8	4,08
2300163	Adapter nipple black	No. 245	3/4X3/8	7,35
2300157	Adapter nipple black	No. 245	3/4X1/2	3,72
2300158	Adapter nipple black	No. 245	1X1/2	7,18
2300159	Adapter nipple black	No. 245	1X3/4	4,08
2300160	Adapter nipple black	No. 245	1 1/4X1/2	11,04
2300161	Adapter nipple black	No. 245	1 1/4X3/4	9,58
2300162	Adapter nipple black	No. 245	1 1/4X1	6,73
2300165	Adapter nipple black	No. 245	1 1/2X3/4	9,58
2300166	Adapter nipple black	No. 245	1 1/2X1	15,03
2300167	Adapter nipple black	No. 245	1 1/2X1 1/4 XXXX	8,08
2300169	Adapter nipple black	No. 245	2X1 1/2	15,47



NR: 245

Item no.	Description	Type	Connection size	Price €
2300172	Sock nipple black	No. 246	3/8X1/4	3,16
2300173	Sock nipple black	No. 246	1/2X1/4	4,23
2300174	Sock nipple black	No. 246	1/2X3/8	3,33
2300175	Sock nipple black	No. 246	3/4X3/8	5,63
2300176	Sock nipple black	No. 246	3/4X1/2	3,54
2300177	Sock nipple black	No. 246	1X1/2	5,55
2300178	Sock nipple black	No. 246	1X3/4	5,69
2300179	Sock nipple black	No. 246	1 1/4X3/4	10,35
2300180	Sock nipple black	No. 246	1 1/4X1	6,58
2300182	Sock nipple black	No. 246	1 1/2X1	12,39
2300183	Sock nipple black	No. 246	1 1/2X1 1/4 XXXX	10,82
2300186	Sock nipple black	No. 246	2X1 1/2	18,12
2300181	Sock nipple black	No. 246	2X1 1/4	17,34



NR: 246

Item no.	Description	Type	Connection size	Price €
2300205	Sock black	No. 270	1/4	2,67
2300187	Sock black	No. 270	3/8	2,51
2300188	Sock black	No. 270	1/2	2,00
2300189	Sock black	No. 270	3/4	2,62
2300190	Sock black	No. 270	1	3,38
2300191	Sock black	No. 270	1 1/4	5,58
2300192	Sock black	No. 270	1 1/2	7,79
2300193	Sock black	No. 270	2	11,68
2300207	Sock black	No. 270	2 1/2	32,90
2300208	Sock black	No. 270	3	39,40
2300206	Sock black	No. 271	1/2	2,00



NR: 270

Item no.	Description	Type	Connection size	Price €
2300194	Nipple black	No. 280	1/8	3,27
2300195	Nipple black	No. 280	1/4	3,04
2300196	Nipple black	No. 280	3/8	3,33
2300197	Nipple black	No. 280	1/2	1,72
2300198	Nipple black	No. 280	3/4	2,31
2300199	Nipple black	No. 280	1	3,19
2300200	Nipple black	No. 280	1 1/4	5,58
2300201	Nipple black	No. 280	1 1/2	6,61
2300202	Nipple black	No. 280	2	11,50
2300204	Nipple black	No. 280	3	25,15



NR: 280

Item no.	Description	Type	Connection size	Price €
2300212	Plug black	No. 290	1/8	2,09
2300213	Plug black	No. 290	1/4	1,58
2300214	Plug black	No. 290	3/8	1,46
2300215	Plug black	No. 290	1/2	1,41
2300216	Plug black	No. 290	3/4	1,89
2300217	Plug black	No. 290	1	2,13
2300218	Plug black	No. 290	1 1/4	3,86
2300219	Plug black	No. 290	1 1/2	4,86
2300220	Plug black	No. 290	2	8,56
2300221	Plug black	No. 290	2 1/2	18,06
2300222	Plug black	No. 290	3	23,38



Item no.	Description	Type	Connection size	Price €
2300243	Cap black	No. 300	1/4	2,07
2300223	Cap black	No. 300	3/8	1,84
2300224	Cap black	No. 300	1/2	2,18
2300225	Cap black	No. 300	3/4	2,60
2300226	Cap black	No. 300	1	3,17
2300227	Cap black	No. 300	1 1/4	4,82
2300228	Cap black	No. 300	1 1/2	5,95
2300229	Cap black	No. 300	2	11,02
2300230	Cap black	No. 300	2 1/2	20,11
2300231	Cap black	No. 300	3	21,94



Item no.	Description	Type	Connection size	Price €
2300233	Clutch black	No. 340	3/8	11,63
2300234	Clutch black	No. 340	1/2	8,80
2300235	Clutch black	No. 340	3/4	9,87
2300236	Clutch black	No. 340	1	11,53
2300237	Clutch black	No. 340	1 1/4	18,96
2300238	Clutch black	No. 340	1 1/2	22,26
2300239	Clutch black	No. 340	2	36,50
2300240	Clutch black	No. 340	2 1/2	82,46
2300241	Clutch black	No. 340	3	114,98
2300242	Clutch black	No. 341	1/4	13,33
2300257	Clutch black	No. 341	3/8	10,21
2300244	Clutch black	No. 341	1/2	8,61
2300245	Clutch black	No. 341	3/4	10,40
2300246	Clutch black	No. 341	1	12,86
2300247	Clutch black	No. 341	1 1/4	20,33
2300248	Clutch black	No. 341	1 1/2	25,95
2300249	Clutch black	No. 341	2	41,46
2300250	Clutch black	No. 341	2 1/2	90,10



Item no.	Description	Type	Connection size	Price €
2300251	Sock nipple black	No. 529A	3/8	3,36
2300252	Sock nipple black	No. 529A	1/2	3,55
2300253	Sock nipple black	No. 529A	3/4	5,16
2300254	Sock nipple black	No. 529A	1	8,09
2300258	Sock nipple black	No. 529A	2	25,16







ZANTINGH

# Heating list

Zantingh BV

## GALVANIZED MALLEABLE FITWORK

Item no.	Description	Type	Connection size	Price €	
7602002	Corner galvanized	No. 1	1/4	5,48	
7602003	Corner galvanized	No. 1	3/8	6,73	
7602004	Corner galvanized	No. 1	1/2	6,04	
7602005	Corner galvanized	No. 1	3/4	10,50	
7602006	Corner galvanized	No. 1	1	14,28	
7602007	Corner galvanized	No. 1	1 1/4	24,61	
7602008	Corner galvanized	No. 1	1 1/2	32,55	
7602009	Corner galvanized	No. 1	2	52,47	
7602102	Corner galvanized	No. 2	1/4	5,86	
7602103	Corner galvanized	No. 2	3/8	6,73	
7602104	Corner galvanized	No. 2	1/2	6,80	
7602105	Corner galvanized	No. 2	3/4	10,53	
7602106	Corner galvanized	No. 2	1	14,28	
7602107	Corner galvanized	No. 2	1 1/4	24,70	
7602108	Corner galvanized	No. 2	1 1/2	30,36	
7602109	Corner galvanized	No. 2	2	42,17	
7602110	Corner galvanized	No. 2	3	149,08	
7602303	Corner galvanized	No. 40	1/2	6,80	
7602304	Corner galvanized	No. 40	3/4	9,22	
7602305	Corner galvanized	No. 40	1	12,90	

Item no.	Description	Type	Connection size	Price €	
7603002	Knee galvanized	No. 90	1/4	3,54	
7603003	Knee galvanized	No. 90	3/8	3,16	
7603004	Knee galvanized	No. 90	1/2	2,13	
7603005	Knee galvanized	No. 90	3/4	3,38	
7603006	Knee galvanized	No. 90	1	4,94	
7603007	Knee galvanized	No. 90	1 1/4	9,51	
7603008	Knee galvanized	No. 90	1 1/2	15,25	
7603009	Knee galvanized	No. 90	2	18,02	
7603018	Knee galvanized	No. 90	3/4X1/2	4,54	
7603019	Knee galvanized	No. 90	1X1/2	6,67	
7603020	Knee galvanized	No. 90	1X3/4	6,98	
7603102	Knee galvanized	No. 92	1/4	3,86	
7603103	Knee galvanized	No. 92	3/8	3,54	
7603104	Knee galvanized	No. 92	1/2	2,44	
7603105	Knee galvanized	No. 92	3/4	3,86	
7603106	Knee galvanized	No. 92	1	6,46	
7603107	Knee galvanized	No. 92	1 1/4	11,10	
7603108	Knee galvanized	No. 92	1 1/2	16,65	
7603109	Knee galvanized	No. 92	2	21,89	

Item no.	Description	Type	Connection size	Price €	
7603320	Knee coupling galv.	No. 96	1/2	14,66	
7603321	Knee coupling galv.	No. 96	3/4	16,97	
7603322	Knee coupling galv.	No. 96	1	24,33	
7603323	Knee coupling galv.	No. 96	1 1/4	40,52	
7603324	Knee coupling galv.	No. 96	1 1/2	48,29	
7603325	Knee coupling galv.	No. 96	2	81,43	
7603330	Knee coupling galv.	No. 98	1/2	14,72	
7603331	Knee coupling galv.	No. 98	3/4	18,66	
7603332	Knee coupling galv.	No. 98	1	25,56	
7603333	Knee coupling galv.	No. 98	1 1/4	42,85	
7603334	Knee coupling galv.	No. 98	1 1/2	52,47	
7603335	Knee coupling galv.	No. 98	2	86,72	





# Heating list

**ZANTINGH**

Item no.	Description	Type	Connection size	Price €	
7604002	Tee galvanized	No. 130	1/4	5,14	 <p>NR: 130</p>
7604003	Tee galvanized	No. 130	3/8	4,40	
7604004	Tee galvanized	No. 130	1/2	2,85	
7604005	Tee galvanized	No. 130	3/4	4,94	
7604006	Tee galvanized	No. 130	1	7,27	
7604007	Tee galvanized	No. 130	1 1/4	12,85	
7604008	Tee galvanized	No. 130	1 1/2	19,98	
7604009	Tee galvanized	No. 130	2	28,10	
7604021	Tee galvanized	No. 130	3/4X1/2	5,32	
7604026	Tee galvanized	No. 130	1X1/2	6,91	
7604027	Tee galvanized	No. 130	1X3/4	7,45	
7604031	Tee galvanized	No. 130	11/4X1/2	11,54	
7604032	Tee galvanized	No. 130	11/4X3/4	12,22	
7604057	Tee galvanized	No. 130	3/4X1/2X1/2	5,69	
7604059	Tee galvanized	No. 130	3/4X3/4X1/2	6,78	
7604064	Tee galvanized	No. 130	1X3/4X3/4	8,67	
7604065	Tee galvanized	No. 130	1X1X1/2	9,11	
7604066	Tee galvanized	No. 130	1X1X3/4	10,04	
7604067	Tee galvanized	No. 130	11/2X1	18,21	
7604068	Tee galvanized	No. 130	11/2X3/4	16,85	

Item no.	Description	Type	Connection size	Price €	
7604302	Cross piece galvanized	No. 180	3/8	10,50	 <p>NR: 180</p>
7604303	Cross piece galvanized	No. 180	1/2	10,32	
7604304	Cross piece galvanized	No. 180	3/4	15,35	
7604305	Cross piece galvanized	No. 180	1	19,01	

Item no.	Description	Type	Connection size	Price €	
7605003	Reducer sock galvanized	No. 240	3/8X1/4	4,26	 <p>NR: 240</p>
7605005	Reducer sock galvanized	No. 240	1/2X1/4	4,45	
7605006	Reducer sock galvanized	No. 240	1/2X3/8	3,72	
7605008	Reducer sock galvanized	No. 240	3/4X3/8	5,18	
7605009	Reducer sock galvanized	No. 240	3/4X1/2	4,37	
7605011	Reducer sock galvanized	No. 240	1X1/2	5,48	
7605012	Reducer sock galvanized	No. 240	1X3/4	5,00	
7605014	Reducer sock galvanized	No. 240	11/4X1/2	10,44	
7605015	Reducer sock galvanized	No. 240	11/4X3/4	9,22	
7605016	Reducer sock galvanized	No. 240	11/4X1	8,94	
7605018	Reducer sock galvanized	No. 240	11/2X3/4	14,28	
7605019	Reducer sock galvanized	No. 240	11/2X1	10,86	
7605020	Reducer sock galvanized	No. 240	11/2X11/4 XXXX	11,99	
7605021	Reducer sock galvanized	No. 240	11/2X1/2	16,12	
7605023	Reducer sock galvanized	No. 240	2X1	21,34	
7605024	Reducer sock galvanized	No. 240	2X11/4	18,84	
7605025	Reducer sock galvanized	No. 240	2X11/2	17,89	
7605026	Reducer sock galvanized	No. 240	21/2X2	48,15	

Item no.	Description	Type	Connection size	Price €	
7605102	Galvanized sock	No. 270	1/4	3,51	 <p>NR: 270</p>
7605103	Galvanized sock	No. 270	3/8	3,00	
7605104	Galvanized sock	No. 270	1/2	2,44	
7605105	Galvanized sock	No. 270	3/4	3,33	
7605106	Galvanized sock	No. 270	1	4,40	
7605107	Galvanized sock	No. 270	1 1/4	6,91	
7605108	Galvanized sock	No. 270	1 1/2	9,96	
7605109	Galvanized sock	No. 270	2	14,72	

Item no.	Description	Type	Connection size	Price €
7606001	Reducer ring galvanized	No. 241	1/4X1/8	3,62
7606003	Reducer ring galvanized	No. 241	3/8X1/4	2,82
7606005	Reducer ring galvanized	No. 241	1/2X1/4	2,19
7606006	Reducer ring galvanized	No. 241	1/2X3/8	2,19
7606008	Reducer ring galvanized	No. 241	3/4X1/4	4,00
7606009	Reducer ring galvanized	No. 241	3/4X3/8	3,04
7606010	Reducer ring galvanized	No. 241	3/4X1/2	2,31
7606012	Reducer ring galvanized	No. 241	1X3/8	5,04
7606013	Reducer ring galvanized	No. 241	1X1/2	3,23
7606014	Reducer ring galvanized	No. 241	1X3/4	3,04
7606016	Reducer ring galvanized	No. 241	1 1/4X1/2	5,58
7606017	Reducer ring galvanized	No. 241	1 1/4X3/4	5,00
7606018	Reducer ring galvanized	No. 241	1 1/4X1	3,72
7606020	Reducer ring galvanized	No. 241	1 1/2X1/2	7,42
7606021	Reducer ring galvanized	No. 241	1 1/2X3/4	8,17
7606022	Reducer ring galvanized	No. 241	1 1/2X1	5,48
7606023	Reducer ring galvanized	No. 241	1 1/2X1 1/4 XXXX	5,58
7606024	Reducer ring galvanized	No. 241	2X1/2	14,84
7606025	Reducer ring galvanized	No. 241	2X3/4	14,66
7606026	Reducer ring galvanized	No. 241	2X1	12,00
7606027	Reducer ring galvanized	No. 241	2X1 1/4	11,45
7606028	Reducer ring galvanized	No. 241	2X1 1/2	10,27
7606032	Reducer ring galvanized	No. 241	2 1/2X2	19,76



Item no.	Description	Type	Connection size	Price €
7606029	Transition nipple galva.	No. 245	3/8X1/4	4,45
7607005	Transition nipple galva.	No. 245	1/2X3/8	5,18
7607008	Transition nipple galva.	No. 245	3/4X1/2	4,49
7607010	Transition nipple galva.	No. 245	1X1/2	9,10
7607011	Transition nipple galva.	No. 245	1X3/4	5,18
7607012	Transition nipple galva.	No. 245	1 1/4X1/2	13,89
7607013	Transition nipple galva.	No. 245	1 1/4X3/4	11,82
7607014	Transition nipple galva.	No. 245	1 1/4X1	8,17
7607016	Transition nipple galva.	No. 245	1 1/2X1	19,01
7607017	Transition nipple galva.	No. 245	1 1/2X1 1/4 XXXX	10,32
7607019	Transition nipple galva.	No. 245	2X1 1/4	21,34
7607020	Transition nipple galva.	No. 245	2X1 1/2	19,46



Item no.	Description	Type	Connection size	Price €
7607021	Reducer sock galvanized	No. 246	3/8X1/4	3,91
7607103	Reducer sock galvanized	No. 246	1/2X1/4	5,18
7607104	Reducer sock galvanized	No. 246	1/2X3/8	4,13
7607105	Reducer sock galvanized	No. 246	3/4X3/8	6,98
7607106	Reducer sock galvanized	No. 246	3/4X1/2	4,45
7607108	Reducer sock galvanized	No. 246	1X1/2	6,80
7607109	Reducer sock galvanized	No. 246	1X3/4	7,23
7607111	Reducer sock galvanized	No. 246	1 1/4X3/4	12,90
7607112	Reducer sock galvanized	No. 246	1 1/4X1	7,99
7607114	Reducer sock galvanized	No. 246	1 1/2X1	15,35
7607115	Reducer sock galvanized	No. 246	1 1/2X1 1/4 XXXX	13,44
7607117	Reducer sock galvanized	No. 246	2X1	25,79
7607118	Reducer sock galvanized	No. 246	2X1 1/2	22,98
7607119	Reducer sock galvanized	No. 246	2 1/2X2	37,36



Item no.	Description	Type	Connection size	Price €
7607201	Nipple galvanized	No. 280	1/8	4,08
7607202	Nipple galvanized	No. 280	1/4	3,62
7607203	Nipple galvanized	No. 280	3/8	4,13
7607204	Nipple galvanized	No. 280	1/2	2,19
7607205	Nipple galvanized	No. 280	3/4	2,82
7607206	Nipple galvanized	No. 280	1	4,08
7607207	Nipple galvanized	No. 280	1 1/4	6,91
7607208	Nipple galvanized	No. 280	1 1/2	7,97
7607209	Nipple galvanized	No. 280	2	14,36
7607210	Nipple galvanized	No. 280	2 1/2	25,79
7607211	Nipple galvanized	No. 280	3	31,05



Item no.	Description	Type	Connection size	Price €
7608001	Plug galvanized	No. 290	1/8	2,62
7608002	Plug galvanized	No. 290	1/4	2,09
7608003	Plug galvanized	No. 290	3/8	1,69
7608004	Plug galvanized	No. 290	1/2	1,69
7608005	Plug galvanized	No. 290	3/4	2,31
7608006	Plug galvanized	No. 290	1	2,54
7608007	Plug galvanized	No. 290	1 1/4	4,82
7608008	Plug galvanized	No. 290	1 1/2	5,86
7608009	Plug galvanized	No. 290	2	10,46
7608010	Plug galvanized	No. 290	2 1/2	22,89
7608011	Plug galvanized	No. 290	3	29,46



Item no.	Description	Type	Connection size	Price €
7608103	Cap galvanized	No. 300	3/8	2,44
7608104	Cap galvanized	No. 300	1/2	2,76
7608105	Cap galvanized	No. 300	3/4	3,33
7608106	Cap galvanized	No. 300	1	3,91
7608107	Cap galvanized	No. 300	1 1/4	5,86
7608108	Cap galvanized	No. 300	1 1/2	7,29
7608109	Cap galvanized	No. 300	2	13,76
7608110	Cap galvanized	No. 300	2 1/2	25,10
7608111	Cap galvanized	No. 300	3	27,37



Item no.	Description	Type	Connection size	Price €
7609003	Coupling galvanized	No. 340	1/4	15,85
7609004	Coupling galvanized	No. 340	1/2	10,96
7609005	Coupling galvanized	No. 340	3/4	12,40
7609006	Coupling galvanized	No. 340	1	14,31
7609007	Coupling galvanized	No. 340	1 1/4	24,61
7609008	Coupling galvanized	No. 340	1 1/2	28,82
7609009	Coupling galvanized	No. 340	2	47,43
7609010	Coupling galvanized	No. 340	2 1/2	104,25
7609101	Coupling galvanized	No. 341	1/4	16,47
7609102	Coupling galvanized	No. 341	3/8	12,85
7609103	Coupling galvanized	No. 341	1/2	10,68
7609104	Coupling galvanized	No. 341	3/4	12,85
7609105	Coupling galvanized	No. 341	1	15,97
7609106	Coupling galvanized	No. 341	1 1/4	25,42
7609107	Coupling galvanized	No. 341	1 1/2	32,55
7609108	Coupling galvanized	No. 341	2	51,93
7609109	Coupling galvanized	No. 341	2 1/2	113,74





Item no.	Description	Type	Connection size	Price €	
7609120	Sock nipple galvanized	No. 529A	3/8	4,37	
7609121	Sock nipple galvanized	No. 529A	1/2	4,45	
7609122	Sock nipple galvanized	No. 529A	3/4	6,64	
7609123	Sock nipple galvanized	No. 529A	1	10,32	
7609124	Sock nipple galvanized	No. 529A	1 1/4	13,17	
7609125	Sock nipple galvanized	No. 529A	1 1/2	19,01	

**MALLEABLE FITTINGS**





**VSH compression fittings for thin-walled metal pipe.**

Item no.	Description	Type	Connection size	prijs €	
3300001	VSH coupling	Nr.1200	12 X 12	7,31	No. 1200 
3300002	VSH coupling	Nr.1200	15 X 15	7,53	
3300003	VSH coupling	Nr.1200	22 X 22	10,65	
3300004	VSH coupling	Nr.1200	28 X 28	18,82	
3300114	VSH coupling	Nr.1201	12 X 10	4,76	No. 1201 
3300091	VSH coupling	Nr.1201	15 X 10	6,18	
3300082	VSH coupling	Nr.1201	15 X 12	6,57	
3300006	VSH coupling	Nr.1201	22 X 15	13,35	
3300007	VSH coupling	Nr.1201	28 X 15	42,13	
3300008	VSH coupling	Nr.1201	28 X 22	20,70	

Item no.	Description	Type	Connection size	prijs €	
3300009	VSH Coupling	Nr.1202	12 X 3/8	4,86	
3300010	VSH Coupling	Nr.1202	12 X 1/2	6,21	
3300011	VSH Coupling	Nr.1202	15 X 3.8	7,06	
3300012	VSH Coupling	Nr.1202	15 X 1/2	6,25	
3300013	VSH Coupling	Nr.1202	15 X 3/4	9,27	
3300100	VSH Coupling	Nr.1202	22 X 1/2	11,50	
3300014	VSH Coupling	Nr.1202	22 X 3/4	9,94	
3300015	VSH Coupling	Nr.1202	22 X 1	13,45	
3300016	VSH Coupling	Nr.1202	28 X 1	14,84	

Item no.	Description	Type	Connection size	prijs €	
3300017	VSH screw bushing	Nr.1204	12 X 3/8	4,22	
3300113	VSH screw bushing	Nr.1204	12 X 1/2	8,63	
3300101	VSH screw bushing	Nr.1204	15 X 3/8	5,50	
3300018	VSH screw bushing	Nr.1204	15 X 1/2	6,78	
3300089	VSH screw bushing	Nr.1204	15 X 3/4	10,37	
3300144	VSH screw bushing	Nr.1204	22 X 1/2	12,14	
3300019	VSH screw bushing	Nr.1204	22 X 3/4	10,12	
3300090	VSH screw bushing	Nr.1204	22 X 1	14,06	
3300020	VSH screw bushing	Nr.1204	28 X 1	14,66	



Item no.	Description	Type	Connection size	prijs €	
3300103	VSH end coupling	Nr.1206	12	3,16	
3300083	VSH end coupling	Nr.1206	15	6,28	
3300084	VSH end coupling	Nr.1206	22	10,51	
3300085	VSH end coupling	Nr.1206	28	15,34	

Item no.	Description	Type	Connection size	prijs €	
3300021	VSH knee coupling	Nr.1210	12 X 12	8,98	
3300022	VSH knee coupling	Nr.1210	15 X 15	8,98	
3300023	VSH knee coupling	Nr.1210	22 X 22	13,99	
3300024	VSH knee coupling	Nr.1210	28 X 28	22,54	

Item no.	Description	Type	Connection size	prijs €	
3300104	VSH knee coupling	Nr.1211	15 X 12	8,52	
3300105	VSH knee coupling	Nr.1211	22 X 15	16,12	
3300146	VSH knee coupling	Nr.1211	28 X 22	23,25	

Item no.	Description	Type	Connection size	prijs €	
3300030	VSH knee K/BT	Nr.1212	12 X 3/8	8,95	
3300031	VSH knee K/BT	Nr.1212	12 X 1/2	8,31	
3300032	VSH knee K/BT	Nr.1212	15 X 1/2	10,26	
3300106	VSH knee K/BT	Nr.1212	15 X 3/4	11,32	
3300160	VSH knee K/BT	Nr.1212	22 X 1/2	13,67	
3300033	VSH knee K/BT	Nr.1212	22 X 3/4	13,14	
3300107	VSH knee K/BT	Nr.1212	22 X 1	18,64	
3300034	VSH knee K/BT	Nr.1212	28 X 1	22,19	

Item no.	Description	Type	Connection size	prijs €	
3300035	VSH knee K/BI	Nr.1214	12 X 3/8	9,16	
3300110	VSH knee K/BI	Nr.1214	12 X 1/2	8,98	
3300109	VSH knee K/BI	Nr.1214	15 X 3/8	10,44	
3300036	VSH knee K/BI	Nr.1214	15 X 1/2	8,02	
3300111	VSH knee K/BI	Nr.1214	15 X 3/4	11,25	
3300145	VSH knee K/BI	Nr.1214	22 X 1/2	13,06	
3300037	VSH knee K/BI	Nr.1214	22 X 3/4	13,92	
3300112	VSH knee K/BI	Nr.1214	22 X 1	18,07	
3300038	VSH knee K/BI	Nr.1214	28 X 1	18,96	

Item no.	Description	Type	Connection size	prijs €	
3300039	VSH Tee	Nr.1220	12X 12 X12	9,76	 No. 1220
3300040	VSH Tee	Nr.1220	15X 15 X15	12,60	
3300041	VSH Tee	Nr.1220	22X 22 X22	18,14	
3300042	VSH Tee	Nr.1220	28X 28 X28	32,77	
3300053	VSH Tee	Nr.1221	12X 15 X12	12,07	
3300054	VSH Tee	Nr.1221	15X 12 X12	12,39	
3300043	VSH Tee	Nr.1221	15X 12 X15	13,21	
3300044	VSH Tee	Nr.1221	15X 15 X12	14,87	
3300045	VSH Tee	Nr.1221	15X 22 X15	16,08	
3300046	VSH Tee	Nr.1221	22X 12 X22	41,57	
3300047	VSH Tee	Nr.1221	22X 15 X15	18,82	 No. 1221
3300048	VSH Tee	Nr.1221	22X 15 X22	18,14	
3300049	VSH Tee	Nr.1221	22X 22 X15	18,82	
3300050	VSH Tee	Nr.1221	22X 28 X22	29,39	
3300051	VSH Tee	Nr.1221	28X 15 X28	25,13	
3300120	VSH Tee	Nr.1221	28X 22 X15	29,07	
3300055	VSH Tee	Nr.1221	28X 22 X22	26,06	
3300056	VSH Tee	Nr.1221	28X 22 X28	30,49	
3300057	VSH Tee	Nr.1221	28X 28 X15	28,72	
3300058	VSH Tee	Nr.1221	28X 28 X22	27,51	
3300052	VSH Tee	Nr.1221	28X 15 X22	26,41	 No. 1223
3300093	VSH Tee	Nr.1223	15X 1/4 X15	12,60	
3300059	VSH Tee	Nr.1223	15X 3/8 X15	12,67	
3300060	VSH Tee	Nr.1223	15X 1/2 X15	14,06	
3300061	VSH Tee	Nr.1223	22X 1/2 X22	18,71	
3300062	VSH Tee	Nr.1223	22X 3/4 X22	19,70	
3300063	VSH Tee	Nr.1223	22X 3/8 X22	43,31	
3300064	VSH Tee	Nr.1223	28X 1/2 X28	22,58	
3300086	VSH Tee	Nr.1223	28X 3/4 X28	25,13	
3300121	VSH Tee	Nr.1223	28X 1 X28	52,94	

Item no.	Description	Type	Connection size	prijs €	
3300142	VSH T-coupling	Nr.1224	15X15X1/2	13,28	
3300141	VSH T-coupling	Nr.1224	22X22X1/2	14,73	
3300161	VSH T-coupling	Nr.1224	22X22X3/4	22,33	
3300147	VSH T-coupling	Nr.1224	28X28X1/2	81,59	

Item no.	Description	Type	Connection size	prijs €	
3300140	VSH cross piece	Nr.1230	15	18,82	
3300128	VSH cross piece	Nr.1230	22	33,48	
3300148	VSH cross piece	Nr.1230	28	44,98	

Item no.	Description	Type	Connection size	prijs €	
3300129	VSH cross piece	No. 1231	22X15X22X15	27,83	
3300130	VSH cross piece	No. 1231	22X15X15X15	On request	

Item no.	Description	Type	Connection size	prijs €	
3300069	VSH H-T-piece	Nr.1235	15X15X15	21,23	
3300108	VSH H-T-piece	Nr.1235	22X15X15	23,15	
3300071	VSH H-T-piece	Nr.1235	22X15X22	25,13	
3300070	VSH H-T-piece	Nr.1235	22X22X22	28,83	

Item no.	Description	Type	Connection size	prijs €	
3300131	VSH jump tee	Nr.1237	15	61,88	
3300127	VSH jump tee	Nr.1237	22	83,62	

Item no.	Description	Type	Connection size	prijs €	
3300132	VSH wall plate	Nr.1240	1/2X15	13,99	

Item no.	Description	Type	Connection size	prijs €	
3300087	VSH couple. m/ont	Nr.1250	15X15	13,74	
3300088	VSH couple. m/ont	Nr.1250	22X22	23,75	

Item no.	Description	Type	Connection size	prijs €	
3300025	VSH knee m/on	Nr.1251	15X15	12,53	
3300026	VSH knee m/on	Nr.1251	22X22	17,96	

Item no.	Description	Type	Connection size	prijs €	
3300076	VSH torque.m/af	Nr.1255	15X15	18,11	
3300077	VSH torque.m/af	Nr.1255	22X22	21,62	

Item no.	Description	Type	Connection size	prijs €	
3300078	VSH knee w/af	Nr.1257	15X1/2	19,70	

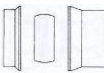
Item no.	Description	Type	Connection size	prijs €	
3300151	VSH Reducer Set	Nr.1270	12X10	1,14	
3300065	VSH Reducer Set	Nr.1270	15X12	1,67	
3300066	VSH Reducer Set	Nr.1270	22X15	3,41	
3300067	VSH Reducer Set	Nr.1270	28X15	6,50	
3300068	VSH Reducer Set	Nr.1270	28X22	4,54	

Item no.	Description	Type	Connection size	prijs €	
3300154	VSH sealing plate	Nr.1271	12	2,66	
3300133	VSH sealing plate	Nr.1271	15	2,91	
3300134	VSH sealing plate	Nr.1271	22	2,66	
3300135	VSH sealing plate	Nr.1271	28	4,37	

Item no.	Description	Type	Connection size	prijs €	
3300155	VSH swivel	Nr.1280	10	1,53	
3300124	VSH swivel	Nr.1280	12	1,53	
3300123	VSH swivel	Nr.1280	15	1,88	
3300125	VSH swivel	Nr.1280	22	2,80	
3300126	VSH swivel	Nr.1280	28	4,47	

Item no.	Description	Type	Connection size	prijs €	
3300074	VSH compression ring	Nr.1281	22	1,42	
3300075	VSH compression ring	Nr.1281	28	1,14	
3300200	VSH compression ring art.	Nr.1281	1/2	1,38	

Item no.	Description	Type	Connection size	prijs €	
3300203	VSH stop valve with drain		15	41,00	
3300204	VSH stop valve with drain		22	56,13	

## FLAMCO MATERIALS

### Wall bracket

Item no.	Description	Connection size	prijs €	
5100000	Flamco wall bracket	BM 8 X 3/8"	1,40	
5100002	Flamco wall bracket	BM 8 X 3/4"	1,93	
5100003	Flamco wall bracket	BM 8 X 1"	On request	
5100004	Flamco wall bracket	BM 10 x 1 1/4"	4,38	
5100005	Flamco wall bracket	BM 10 X 1 1/2"	3,14	
5100006	Flamco wall bracket	BM 10 X 2"	3,22	
5100007	Flamco wall bracket	BM 8 X 12 MM	1,97	
5100009	Flamco wall bracket	BM 8 1/2 X 22MM	1,93	
5100052	Flamco wall bracket	BM 8 X 28 MM	1,92	
5100053	Flamco wall bracket	BM 8 X 33-38	On request	
5100043	Flamco wall bracket	BM 10 X 51/57	2,26	
5100011	Flamco wall bracket	BMK 8 X 12 MM	2,99	
5100012	Flamco wall bracket	BMK 8 X 15 MM	3,06	
5100013	Flamco wall bracket	BMK 8 X 22 MM	3,29	
5100014	Flamco wall bracket	BMK 8 X 28 MM	3,29	

### Suspension sling

Item no.	Description	Connection size	prijs €	
5100017	Flamco suspension sling	BK 6 X 3/4"	1,46	
5100114	Flamco suspension sling	BK 6 X 15	1,44	
5100115	Flamco suspension sling	BK 6 X 22	1,60	
5100116	Flamco suspension sling	BK 6 X 28	1,50	
5100027	Flamco suspension sling	BK 8 X 82/89	3,63	
5100111	Flamco suspension sling	BKK 6 X 15	4,39	
5100112	Flamco suspension sling	BKK 6 X 22	4,94	
5100113	Flamco suspension sling	BKK 6 X 28	5,15	

### Washer

Item no.	Description	Connection size	prijs €	
5100029	Flamco washer	S 6 S	0,04	

<b>Wall bracket with rubber</b>			
Item no.	Description		prijs €
5100250	Flamco wall bracket with rubber	BSA 8 – 20-24	3,69
5100251	Flamco wall bracket with rubber	BSA 8 – 33-37	4,23

<b>Sliding nut</b>			
Item no.	Description	Connection size	prijs €
5100032	Flamco sliding nut	M 6 S	0,77
5100033	Flamco sliding nut	M 8 S	0,76
5100045	Flamco sliding nut	M 10 S	0,76
5100117	Flamco sliding nut	M 12 S	2,06



Item no.	Description	Connection size	prijs €
5100261	Flamco wood thread pin	8 X 80 HO	0,77

<b>Coupling piece</b>			
Item no.	Description	Connection size	prijs €
5100096	Flamco coupling piece	KSM 6	0,69
5100097	Flamco coupling piece	KSM 7	0,87
5100098	Flamco coupling piece	KSM 9	1,51

<b>Clamp rosette</b>			
Item no.	Description	Connection size	prijs €
5100039	Flamco clamp rosette	RK 3/4"	0,83
5100040	Flamco clamp rosette	RK 1"	0,86



<b>Rail</b>			
Item no.	Description		prijs €
5100034	Flamco rail R1 galvanized per meter		10,54

<b>Beam clamp</b>			
Item no.	Description	Connection size	prijs €
5100085	Flamco beam clamp	KC 6 galvanized	17,39
5100086	Flamco beam clamp	KC 8 galvanized	16,30

<b>Zamak Saddle</b>			
Item no.	Description	Connection size	prijs €
5104008	Zamak saddle	28 mm	3,84

## SUSPENSION MATERIAL HOUSE HEATING INSTALLATION

<b>Double pipe clamp</b>			
Item no.	Description	Connection size	prijs €
5101000	Double pipe clamp	15 mm	1,91
5101001	Double pipe clamp	22 mm	1,97
5102010	Double pipe clamp	22 mm = rubber	8,07

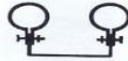

<b>Clic saddle</b>			
Item no.	Description	Connection size	prijs €
5101022	Clic saddle	12 mm	0,57
5101016	Clic saddle	22 mm	0,82





ZANTINGH

C.V. – PIPE + RED COPPER PIPE

C.V. - PIPE

Minimum order quantity : 1 length = 6 meters  
Price : per meter

Item no.	Description	Size	prijs €
2501000	C.V. PIPE	12 X 1.25 mm	1,81
2501002	C.V. PIPE	15 X 1.20 mm	1,73
2501003	C.V. PIPE	22 X 1.20 mm	2,24
2501004	C.V. PIPE	28 X 1.20 mm	3,25



RED COPPER PIPE

Minimum order quantity : 1 length = 5 meters  
Price : per meter

Item no.	Description	Size	Note	prijs €
2502000	Red copper pipe	10 X 12 mm		P.O.A.
2502001	Red copper pipe	13 X 15 mm		P.O.A.
2502002	Red copper pipe	19.8 X 22 mm		P.O.A.
2502003	Red copper pipe	25.6 X 28 mm		P.O.A.
2502010	Red copper pipe	32.4 X 35 mm		P.O.A.
2502004	Red copper pipe	4/6 mm	on a roll	P.O.A.
2502005	Red copper pipe	6/8 mm	on a roll	P.O.A.
2502006	Red copper pipe	3/8"	on a roll	P.O.A.
2502007	Red copper pipe	1/2"	on a roll	P.O.A.
2502008	Red copper pipe	15mm	on a roll	P.O.A.
2502009	Red copper pipe	8/10P	on a roll	P.O.A.
2502011	Red copper pipe	4 mm	on a roll	P.O.A.



## CHAPTER 6

### *Welding supplies*



**3.1 Certificates**

For all steel components, fittings, and flanges, it is possible to obtain a 3.1 material certificate. This must be requested in advance when placing the purchase order. It is not possible to request a 3.1 certificate after the order has been placed. The cost for a 3.1 certificate is € 30,00 NET per order.

WELDING ELBOWS 90 DEGREES				
Item no.	Description	Connection size		Price €
2400001	Welding elbow	21.3 X 2.0 mm	3S 90gr.	0,93
2400002	Welding elbow	26.9 X 2.3 mm	3S 90gr.	1,15
2400027	Welding elbow	31.8 X 2.6 mm	3S 90gr.	1,51
2400003	Welding elbow	33.7 X 2.6 mm	3S 90gr.	1,59
2400004	Welding elbow	38.0 X 2.6 mm	3S 90gr.	2,43
2400005	Welding elbow	42.4 X 2.6 mm	3S 90gr.	2,37
2400006	Welding elbow	44.5 X 2.6 mm	3S 90gr.	3,24
2400007	Welding elbow	48.3 X 2.6 mm	3S 90gr.	3,18
2400008	Welding elbow	51 X 2.6 mm	3S 90gr.	4,88
2400009	Welding elbow	57 X 2.9 mm	3S 90gr.	5,37
2400010	Welding elbow	60.3 X 2.9 mm	3S 90gr.	5,06
2400011	Welding elbow	63.5 X 2.9 mm	3S 90gr.	7,64
2400012	Welding elbow	70 X 2.9 mm	3S 90gr.	10,48
2400013	Welding elbow	76.1 X 3.6 mm	3S 90gr.	8,51
2400014	Welding elbow	82.5 X 3.2 mm	3S 90gr.	15,27
2400015	Welding elbow	88.9 X 3.2 mm	3S 90gr.	11,91
2400016	Welding elbow	95 X 3.6 mm	3S 90gr.	21,61
2400017	Welding elbow	101.6X 3.6 mm	3S 90gr.	22,33
2400018	Welding elbow	108 X 3.6 mm	3S 90gr.	23,58
2400019	Welding elbow	114.3 X 3.6 mm	3S 90gr.	21,79
2400020	Welding elbow	121 X 4.0 mm	3S 90gr.	40,86
2400021	Welding elbow	127 X 4.0 mm	3S 90gr.	47,69
2400022	Welding elbow	133 X 4.0 mm	3S 90gr.	39,56
2400023	Welding elbow	139.7 X 4.0 mm	3S 90gr.	41,20
2400024	Welding elbow	152.4 X 4.5 mm	3S 90gr.	68,11
2400025	Welding elbow	159 X 4.5 mm	3S 90gr.	58,12
2400026	Welding elbow	168.3 X 4.5 mm	3S 90gr.	53,10
2400028	Welding elbow	193.7 X 5.4 mm	3S 90gr.	116,55
2400029	Welding elbow	219.1 X 6.3 mm	3S 90gr.	138,31
2400030	Welding elbow	273 X 6.3 mm	3S 90gr.	223,84
2400031	Welding elbow	323.9 X 7.1 mm	3S 90gr.	305,10
2400039	Welding elbow	355.6 X 8 mm	3S 90gr.	528,85
2400040	Welding elbow	406.4 X 8.8 mm	3S 90gr.	713,66
WELDING ELBOWS 180 DEGREES				
Item no.	Description	Connection size		Price €
2400032	Welding elbow	33.7 X 2.6 mm	3S 180gr.	10,40
2400034	Welding elbow	51 X 2.6 mm	3S 180gr.	15,84
2400037	Welding elbow	26.9 X 2.3 mm	5S 180gr.	22,31
2400035	Welding elbow	51 X 2.6 mm	5S 180gr.	15,61
WELDING REDUCER				
Item no.	Description	Connection size		Price €
2401016	Weld reducer	26.9 X 21.3 mm		2,87
2401001	Weld reducer	33.7 X 21.3 mm		2,58
2401002	Weld reducer	33.7 X 26.9 mm		2,53
2401003	Weld reducer	42.4 X 26.9 mm		3,10
2401004	Weld reducer	42.4 X 33.7 mm		2,53
2401005	Weld reducer	48.3 X 26.9 mm		3,69
2401000	Weld reducer	48.3 X 33.7 mm		3,10
2401006	Weld reducer	48.3 X 42.4 mm		3,10
2401007	Weld reducer	60.3 X 33.7 mm		5,31
2401008	Weld reducer	60.3 X 42.4 mm		3,91
2401009	Weld reducer	60.3 X 48.3 mm		3,52



WELDING REDUCER			
Item no.	Description	Connection size	Price €
2401129	Weld reducer	76.1 X 33.7 mm	8,06
2401010	Weld reducer	76.1 X 42.4 mm	5,68
2401011	Weld reducer	76.1 X 48.3 mm	4,85
2401012	Weld reducer	76.1 X 60.3 mm	4,26
2401013	Weld reducer	88.9 X 48.3 mm	6,77
2401014	Weld reducer	88.9 X 60.3 mm	6,15
2401015	Weld reducer	88.9 X 76.1 mm	6,08
2401017	Weld reducer	108 X 57 mm	10,87
2401216	Weld reducer	108 X 60.3 mm	9,57
2401018	Weld reducer	108 X 76.1 mm	8,76
2401019	Weld reducer	108 X 88.9 mm	8,76
2401020	Weld reducer	114.3 X 60.3 mm	9,82
2401021	Weld reducer	114.3 X 76.1 mm	9,35
2401022	Weld reducer	114.3 X 88.9 mm	9,13
2401023	Weld reducer	133 X 57 mm	20,87
2401217	Weld reducer	133 X 60.3 mm	21,63
2401024	Weld reducer	133 X 76.1 mm	18,28
2401025	Weld reducer	133 X 88.9 mm	14,94
2401026	Weld reducer	133 X 108 mm	15,18
2401107	Weld reducer	133 X 114.3 mm	13,53
2401127	Weld reducer	139.7 X 76.1 mm	20,25
2401027	Weld reducer	139.7 X 88.9 mm	15,82
2401128	Weld reducer	139.7 X 108.0 mm	13,80
2401028	Weld reducer	139.7 X 114.3 mm	14,76
2401218	Weld reducer	159 X 60.3 mm	30,48
2401029	Weld reducer	159 X 76.1 mm	24,65
2401030	Weld reducer	159 X 88.9 mm	21,75
2401031	Weld reducer	159 X 108 mm	19,54
2401125	Weld reducer	159 X 114.3 mm	18,51
2401032	Weld reducer	159 X 133 mm	19,85
2401134	Weld reducer	159 X 139.7 mm	19,85
2401145	Weld reducer	168.3 X 88.9 mm	25,33
2401033	Weld reducer	168.3 X 114.3 mm	21,35
2401126	Weld reducer	168.3 X 133 mm	19,27
2401034	Weld reducer	168.3 X 139.7 mm	20,71
2401123	Weld reducer	193.7 X 108 mm	63,40
2401035	Weld reducer	193.7 X 133 mm	50,10
2401220	Weld reducer	193.7 X 168.3 mm	36,18
2401036	Weld reducer	219.1 X 108 mm	62,61
2401037	Weld reducer	219.1 X 114.3 mm	52,89
2401038	Weld reducer	219.1 X 133 mm	46,54
2401139	Weld reducer	219.1 X 139.7 mm	42,07
2401039	Weld reducer	219.2 X 159 mm	39,30
2401042	Weld reducer	219.1 X 168.3 mm	39,98
2401040	Weld reducer	273 X 133 mm	81,80
2401041	Weld reducer	273 X 159 mm	65,54
2401221	Weld reducer	273 X 168.3 mm	60,28
2401043	Weld reducer	273 X 219.1 mm	54,33
2401044	Weld reducer	323.9 X 219.1 mm	105,35
2401045	Weld reducer	323.9 X 273 mm	95,65
2401146	Weld reducer	355.6 X 273 mm	251,35
2401140	Weld reducer	355.6 X 323.9 mm	239,63



<b>WELDING SADDLE PIECE</b>			
Item no.	Description	Connection size	Price €
2401108	Welding saddle	42.4 mm	5,15
2401046	Welding saddle	48.3 mm	5,22
2401047	Welding saddle	57 mm	6,08
2401048	Welding saddle	60.3 mm	5,51
2401049	Welding saddle	76.1 mm	7,89
2401050	Welding saddle	88.9 mm	11,56
2401051	Welding saddle	108 mm	18,25
2401052	Welding saddle	114.3 mm	21,11
2401053	Welding saddle	133 mm	29,48
2401130	Welding saddle	139.7 mm	31,18
2401054	Welding saddle	159 mm	46,78
2401131	Welding saddle	168.3 mm	48,62
2401133	Welding saddle	219.1 mm	92,54
2401143	Welding saddle	273.0 mm	146,37
2401144	Welding saddle	323.0 mm	246,33

<b>WELDING SHOE</b>			
Item no.	Description	Connection size	Price €
2401055	Welding shoe	48.3 mm	40,12
2401117	Welding shoe	57.0 mm	38,09
2401056	Welding shoe	60.3 mm	44,57
2401057	Welding shoe	76.1 mm	59,45
2401058	Welding shoe	88.9 mm	58,98
2401059	Welding shoe	108.0 mm	81,77
2401060	Welding shoe	114.3 mm	103,53
2401061	Welding shoe	133.0 mm	74,70
2401062	Welding shoe	139.7 mm	175,13
2401063	Welding shoe	159.0 mm	201,86
2401132	Welding shoe	168.3 mm	244,16
2401109	Welding shoe	219.1 mm	504,75
2401141	Welding shoe	273.0 mm	707,09
2401142	Welding shoe	323.0 mm	973,55

<b>WELEDDED BOTTOM</b>			
Item no.	Description	Connection size	Price €
2401121	Welded bottom	33.7 mm	0,94
2402066	Welded bottom	38.0 mm	2,93
2401112	Welded bottom	42.4 mm	1,07
2401064	Welded bottom	48.3 mm	1,29
2401065	Welded bottom	51.0 mm	3,64
2401201	Welded bottom	57.0 mm	1,75
2401066	Welded bottom	60.3 mm	3,14
2401116	Welded bottom	63.5 mm	4,35
2401067	Welded bottom	70.0 mm	2,46
2401068	Welded bottom	76.1 mm	2,08
2401069	Welded bottom	82.5 mm	5,39
2401070	Welded bottom	88.9 mm	2,67
2401071	Welded bottom	95.0 mm	11,69
2401106	Welded bottom	101.6 mm	6,94
2401072	Welded bottom	108.0 mm	8,05
2401073	Welded bottom	114.3 mm	9,39
2401114	Welded bottom	121.0 mm	14,02
2401115	Welded bottom	127.0 mm	13,06
2401074	Welded bottom	133.0 mm	9,87
2401075	Welded bottom	139.7 mm	10,11
2401206	Welded bottom	152.4 mm	17,58
2401076	Welded bottom	159.0 mm	15,48

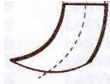

WELDED BOTTOM			
Item no.	Description	Connection size	Price €
2401077	Welded bottom	168.3 mm	14,43
2401078	Welded bottom	193.7 mm	29,13
2401079	Welded bottom	219.1 mm	26,96
2401080	Welded bottom	273.0 mm	44,71
2401081	Welded bottom	323.9 mm	90,71
2401202	Welded bottom	355.6 mm	104,98
2401204	Welded bottom	406.4 mm	128,21
2401205	Welded bottom	419.0 mm	201,72
2401212	Welded bottom	457.2 mm	164,49
2401122	Welded bottom	508 mm	188,57
2401203	Welded bottom	609.6 mm	175,84

WELDING PLATES			
Item no.	Description	Diameter	Price €
2401207	Welding plate	17 mm	0,48
2401111	Welding plate	22 mm	0,39
2401092	Welding plate	27 mm	0,43
2401093	Welding plate	34 mm	0,76
2401113	Welding plate	38 mm	0,41
2401213	Welding plate	42.8 mm	1,32
2401120	Welding plate	44 mm	0,46
2401082	Welding plate	51 mm	0,48
2401135	Welding plate	57 mm	0,87
2401094	Welding plate	60 mm	0,98
2401095	Welding plate	63 mm	0,61
2401096	Welding plate	70 mm	2,80
2401097	Welding plate	76 mm	1,11
2401098	Welding plate	83 mm	1,52
2401099	Welding plate	89 mm	1,30
2401100	Welding plate	95 mm	5,51
2401101	Welding plate	102 mm	7,35
2401102	Welding plate	108 mm	7,35
2401103	Welding plate	114 mm	3,69
2401119	Welding plate	121 mm	8,57
2401086	Welding plate	127 mm	4,03
2401104	Welding plate	133 mm	7,68
2401200	Welding plate	139 mm	4,51
2401105	Welding plate	159 mm	7,03
2401136	Welding plate	168 mm	7,42
2401137	Welding plate	192 mm	10,04
2401118	Welding plate	219 mm	13,10
2401214	Welding plate	38-3/4" Centric	0,43
2401210	Welding plate	38-1/2" Centric	0,43
2401209	Welding plate	44-3/4" Centric	0,87
2401211	Welding plate	44-1/2" Centric	0,46
2401084	Welding plate	51-3/8" Centric	1,95
2401083	Welding plate	51-1/2" Centric	0,48
2401085	Welding plate	51-3/4" Centric	0,48
2401110	Welding plate	51-1" Centric	0,48
2401087	Welding plate	51-3/8" Eccentric	1,95
2401088	Welding plate	51-1/2" Eccentric	1,95
2401089	Welding plate	51-3/4" Eccentric	1,95
2401090	Welding plate	51-1" Eccentric	1,95

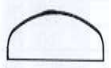

<b>WELD TEE</b>			
Item no.	Description	Connection size	Price €
2403015	Weld tee	26.9 X 2.3 mm	6,80
2403010	Weld tee	33.7 X 2.6 mm	6,79
2403011	Weld tee	42.4 X 2.6 mm	8,61
2403012	Weld tee	48.3 X 2.6 mm	8,69
2403014	Weld tee	57.0 X 2.9 mm	11,32
2403001	Weld tee	60.3 X 2.9 mm	11,75
2403002	Weld tee	76.1 X 2.9 mm	15,30
2403003	Weld tee	88.9 X 3.2 mm	20,02
2403004	Weld tee	108.0 X 3.6 mm	35,17
2403005	Weld tee	114.3 X 3.6 mm	30,44
2403006	Weld tee	133.0 X 4.0 mm	46,90
2403008	Weld tee	139.7 X 4.0 mm	47,89
2403007	Weld tee	159.0 X 4.5 mm	71,73
2403013	Weld tee	168.3 X 4.5 mm	69,90
2403009	Weld tee	219.1 X 6.3 mm	218,40
2403016	Weld tee	273.0 X 6.3 mm	353,70
2403017	Weld tee	323.0 X 7.1 mm	580,95



<b>WELD SOCK NO. 16</b>				
Item no.	Description	Connection size	Length	Price €
2402002	Welding sock	1/8"	17 mm	0,54
2402001	Welding sock	1/4"	25 mm	0,54
2402003	Welding sock	3/8"	26 mm	0,54
2402004	Welding sock	1/2"	34 mm	0,57
2402000	Welding sock long model	1/2"	80 mm	3,60
2402005	Welding sock	3/4"	36 mm	0,92
2402006	Welding sock	1"	43 mm	1,28
2402007	Welding sock	1 1/4"	48 mm	1,80
2402008	Welding sock	1 1/2"	48 mm	2,15
2402009	Welding sock	2"	56 mm	2,90
2402010	Welding sock	2 1/2"	66 mm	5,25
2402011	Welding sock	3"	71 mm	7,21



<b>HALF PIPE NIPPLES BLACK</b>			
Item no.	Description	Connection size	Price €
2402077	Half black pipe nipple	3/8" X 80mm	0,76
2402069	Half black pipe nipple	3/8" X 100mm	0,79
2402078	Half black pipe nipple	1/2" x 80mm	0,73
2402067	Half black pipe nipple	1/2" X 100mm	0,70
2402086	Half black pipe nipple	3/4" X 50mm	0,71
2402080	Half black pipe nipple	3/4" X 80mm	0,82
2402068	Half black pipe nipple	3/4" x 100mm	0,85
2402079	Half black pipe nipple	1" X 80mm	1,19
2402070	Half black pipe nipple	1" X 100mm	1,38
2402071	Half black pipe nipple	1 1/4"X 100mm	1,89
2402072	Half black pipe nipple	1 1/2"X 100mm	2,25
2402074	Half black pipe nipple	2" x 100mm	2,74
2402075	Half black pipe nipple	2 1/2"X 100mm	4,72
2402076	Half black pipe nipple	3" X 100mm	6,28
2402081	Half black pipe nipple	4" x 100mm	8,92



WHOLE PIPE NIPPLES BLACK			
Item no.	Description	Connection size	Price €
2402073	Pipe nipple whole black	1/4" X 50mm	0,69
2402013	Pipe nipple whole black	1/4" X 100mm	0,85
2402014	Pipe nipple whole black	1/4" X 150mm	1,14
2402015	Pipe nipple whole black	1/4" X 200mm	1,35
2402016	Pipe nipple whole black	1/4" X 250mm	1,80
2402017	Pipe nipple whole black	1/4" X 300mm	2,00
2402018	Pipe nipple whole black	3/8" X 100mm	0,79
2402019	Pipe nipple whole black	3/8" x 150mm	1,12
2402020	Pipe nipple whole black	3/8" X 200mm	1,30
2402021	Pipe nipple whole black	3/8" x 250mm	1,58
2402022	Pipe nipple whole black	3/8" X 300mm	1,75
2402063	Pipe nipple whole black	1/2" X 50mm	0,67
2402023	Pipe nipple whole black	1/2" X 100mm	0,78
2402024	Pipe nipple whole black	1/2" X 150mm	1,15
2402025	Pipe nipple whole black	1/2" X 200mm	1,53
2402026	Pipe nipple whole black	1/2" X 250mm	1,91
2402027	Pipe nipple whole black	1/2" X 300mm	2,22
2402064	Pipe nipple whole black	3/4" X 50mm	0,71
2402028	Pipe nipple whole black	3/4" x 100mm	0,96
2402029	Pipe nipple whole black	3/4" x 150mm	1,41
2402030	Pipe nipple whole black	3/4" x 200mm	1,83
2402031	Pipe nipple whole black	3/4" X 250mm	2,29
2402032	Pipe nipple whole black	3/4" X 300mm	2,68
2402083	Pipe nipple whole black	1" X 50mm	0,99
2402033	Pipe nipple whole black	1" x 100mm	1,40
2402034	Pipe nipple whole black	1" x 150mm	1,99
2402035	Pipe nipple whole black	1" x 200mm	2,80
2402036	Pipe nipple whole black	1" x250mm	3,82
2402037	Pipe nipple whole black	1" x 300mm	4,17
2402038	Pipe nipple whole black	1 1/4"X100mm	1,91
2402039	Pipe nipple whole black	1 1/4"X150mm	2,68
2402040	Pipe nipple whole black	1 1/4"X200mm	3,53
2402041	Pipe nipple whole black	1 1/4"X250mm	4,20
2402042	Pipe nipple whole black	1 1/4"X300mm	5,31
2402082	Pipe nipple whole black	1 1/2" X 50mm	1,41
2402043	Pipe nipple whole black	1 1/2"X100mm	2,25
2402044	Pipe nipple whole black	1 1/2"X150mm	3,24
2402045	Pipe nipple whole black	1 1/2"X200mm	4,28
2402046	Pipe nipple whole black	1 1/2"X250mm	5,25
2402047	Pipe nipple whole black	1 1/2" X300mm	6,11
2402048	Pipe nipple whole black	2"X100mm	2,74
2402049	Pipe nipple whole black	2" x 150mm	4,32
2402050	Pipe nipple whole black	2"x200mm	5,83
2402051	Pipe nipple whole black	2" x 250mm	7,64
2402052	Pipe nipple whole black	2"X300mm	8,79
2402053	Pipe nipple whole black	2 1/2" X100mm	4,72
2402054	Pipe nipple whole black	2 1/2"X150mm	6,41
2402055	Pipe nipple whole black	2 1/2"X200mm	8,93
2402056	Pipe nipple whole black	2 1/2"X250mm	9,85
2402057	Pipe nipple whole black	2 1/2"X300mm	12,17
2402058	Pipe nipple whole black	3"X100mm	6,28
2402059	Pipe nipple whole black	3" x150mm	8,56
2402060	Pipe nipple whole black	3" x200mm	11,33
2402061	Pipe nipple whole black	3"X250mm	13,02
2402062	Pipe nipple whole black	3" x 300mm	15,56
2402065	Pipe nipple whole black	4" x300mm	22,86





**LEADERS**

Leaders				
Price : NET PRICES				
Other sizes on request				
Item no.	Description	Size	Heart to Heart	Price €
2450000	Headpiece	51.0 mm	420 mm	8,07
2450001	Headpiece	44.5 mm	420 mm	8,04
2450002	Headpiece	51.0 mm	520 mm 250 mm	8,62
2450003	Headpiece	44.5 mm	550 mm	8,55
2450004	Headpiece	51.0 mm	550 mm	8,72



**HOOD BRACKETS**

Cap brackets DIN 3567				
Pipe brackets / clamp per set (2pcs).				
Item no.	Description	Color	Size	Price per set €
2520000	Pipe bracket / clamp	Black	42 mm	3,08
2520001	Pipe bracket / clamp	Black	48 mm	3,16
2520002	Pipe bracket / clamp	Black	57 mm	6,58
2520003	Pipe bracket / clamp	Black	60 mm	3,40
2520004	Pipe bracket / clamp	Black	76 mm	4,16
2520005	Pipe bracket / clamp	Black	89 mm	4,36
2520006	Pipe bracket / clamp	Black	108 mm	7,01
2520007	Pipe bracket / clamp	Black	114 mm	7,16
2520008	Pipe bracket / clamp	Black	133 mm	13,06
2520009	Pipe bracket / clamp	Black	139 mm	12,92
2520010	Pipe bracket / clamp	Black	159 mm	14,88
2520011	Pipe bracket / clamp	Black	168 mm	16,16
2520012	Pipe bracket / clamp	Black	219 mm	20,12
2520013	Pipe bracket / clamp	Black	273 mm	23,24
2520014	Pipe bracket / clamp	Black	323 mm	33,11

**STAINLESS STEEL EXPANSION JOINT WITH WELD END**

<b>EXPANSION JOINTS WITH WELDED END</b>				
A universal expansion joint with weld end for various applications in refrigeration systems and flue gas systems. Compensators with flange connection on request.				
Item no.	Description	Connection size	Weld end	Price €
2504020	Stainless Steel Compensator	DN 50 / 60	Stainless steel	147,08
2504021	Stainless Steel Compensator	DN 65 / 76.1	Stainless steel	152,06
2504022	Stainless Steel Compensator	DN 80 / 88.9	Stainless steel	156,48
2504023	Stainless Steel Compensator	DN 100 / 114.3	Stainless steel	191,28
2504024	Stainless Steel Compensator	DN 125 / 129	Stainless steel	230,40
2504025	Stainless Steel Compensator	DN 125 / 139	Stainless steel	236,08
2504026	Stainless Steel Compensator	DN 150 / 154	Stainless steel	284,40
2504027	Stainless Steel Compensator	DN 150 / 168.3	Stainless steel	282,86
2504028	Stainless Steel Compensator	DN 200 / 219.1	Stainless steel	338,88
2504029	Stainless Steel Compensator	DN 250 / 254	Stainless steel	435,60
2504030	Stainless Steel Compensator	DN 250 / 273	Stainless steel	452,58
2504031	Stainless Steel Compensator	DN 300 / 304	Stainless steel	594,00
2504000	Stainless Steel Compensator	DN 40 / 48	Steel	100,60
2504001	Stainless Steel Compensator	DN 50 / 60	Steel	110,39
2504002	Stainless Steel Compensator	DN 65 / 76	Steel	125,75
2504003	Stainless Steel Compensator	DN 80 / 89	Steel	131,35
2504005	Stainless Steel Compensator	DN 100 / 114	Steel	167,47
2504006	Stainless Steel Compensator	DN 125 / 139	Steel	183,42
2504007	Stainless Steel Compensator	DN 150 / 168	Steel	213,97
2504008	Stainless Steel Compensator	DN 175 / 193	Steel	224,23
2504009	Stainless Steel Compensator	DN 200 / 219	Steel	249,56
2504010	Stainless Steel Compensator	DN 250 / 273	Steel	303,95
2504011	Stainless Steel Compensator	DN 300 / 323	Steel	441,54



**EXPANSION JOINTS WITH FLANGES**

**RUBBER EXPANSION JOINTS WITH FLANGES**

A universal EPDM rubber expansion joint in various applications heating and cooling installations.

Technical data:

Bellows element : EPDM Rubber  
 Connection : Galvanized steel flange  
 Max. working pressure : 20°C - 16 bar  
 Max. negative pressure : 0.5 bar

Item no.	Description	Connection size	Installation size	Price €
2505011	Expansion Joints EPDM	DN 32 / PN16	130 mm	42,08
2505007	Expansion Joints EPDM	DN 40 / PN16	130 mm	44,78
2505000	Expansion Joints EPDM	DN 50 / PN16	130 mm	57,40
2505001	Expansion Joints EPDM	DN 65 / PN16	130 mm	68,52
2505002	Expansion Joints EPDM	DN 80 / PN16	130 mm	83,88
2505003	Expansion Joints EPDM	DN 100 / PN16	130 mm	100,14
2505004	Expansion Joints EPDM	DN 125 / PN16	130 mm	127,02
2505005	Expansion Joints EPDM	DN 150 / PN16	130 mm	174,98
2505006	Expansion Joints EPDM	DN 200 / PN16	130 mm	278,52
2505012	Expansion Joints EPDM	DN 250 / PN16	130 mm	374,06
2505013	Expansion Joints EPDM	DN 300 / PN16	130 mm	485,98



**RUBBER EXPANSION JOINTS (ROTEX) WITH FLANGES**

A universal rubber expansion joint for various applications in heating and cooling installations.

Technical data:

Bellows element : EPDM rubber (ROTEX)  
 Connection : Galvanized steel flange  
 Max. working pressure : 100°C - 10 bar  
 : 110°C - 6 bar  
 Peak temperature : 130°C

Item no.	Description	Connection size	Installation size	Price €
2505050	Expansion Joints Rotex	DN 40 / PN10/16	130 mm	621,62
2505051	Expansion Joints Rotex	DN 50 / PN10/16	130 mm	651,64
2505052	Expansion Joints Rotex	DN 65 / PN10/16	130 mm	707,34
2505053	Expansion Joints Rotex	DN 80 / PN10/16	130 mm	774,54
2505054	Expansion Joints Rotex	DN100 / PN10/16	130 mm	863,58
2505055	Expansion Joints Rotex	DN125 / PN10/16	130 mm	951,80
2505057	Expansion Joints Rotex	DN200 / PN10/16	130 mm	1.445,90



# CHAPTER 7

## *Expansion tanks*



**PRESSURE EXPANSION VESSELS**

Zilmet Ziflex-H Diaphragm Pressure Expansion Vessels (red) according to the Pressure Equipment Directive 2014/68/EU and DIN EN 13831.  
 Use in closed heating systems according to DIN EN 12828 and refrigeration systems.

**Technical specifications**  
 Permissible operating temperature : 70°C  
 Max. working pressure : 8 to 50 litres - 4 bar / 120°C : 80 to 900 litres - 6 bar / 120°C  
 Connection : 8 to 50 litres - G 3/4" male thread : 80 to 900 litres - G 1" male thread  
 Membrane : according to DIN4807 T3. Approval according to the Pressure Equipment Directive 2014/68/EU.

Item no.	Description	Contents	Bar	Price €
2700022	Expansion tank Ziflex-H	8 litres	1.5 bar	47,81
2700023	Expansion tank Ziflex-H	12 litres	1.5 bar	49,26
2700028	Expansion tank Ziflex-H	25 litres	1.5 bar	64,23
2700024	Expansion tank Ziflex-H	35 litres	1.5 bar	82,06
2700025	Expansion tank Ziflex-H	50 litres	1.5 bar	101,58
2700026	Expansion tank Ziflex-H	80 litres	2.5 bar	158,16
2700027	Expansion tank Ziflex-H	105 litres	2.5 bar	283,55
2700029	Expansion tank Ziflex-H	150 litres	2.5 bar	332,75
2700030	Expansion tank Ziflex-H	200 litres	2.5 bar	417,92
2700031	Expansion tank Ziflex-H	250 litres	2.5 bar	576,09
2700032	Expansion tank Ziflex-H	300 litres	2.5 bar	664,11
2700033	Expansion tank Ziflex-H	400 litres	2.5 bar	818,04
2700034	Expansion tank Ziflex-H	500 litres	2.5 bar	1.131,55
2700035	Expansion tank Ziflex-H	600 litres	2.5 bar	1.668,89
2700036	Expansion tank Ziflex-H	800 litres	2.5 bar	2.226,88
2700037	Expansion tank Ziflex-H	900 litres	2.5 bar	2.430,03



Item no.	Description	Price €
2700000	Connection console	18,23
2700013	Expansion tank coupling 3/4"	31,48
2700016	Expansion tank coupling 1"	42,72

# CHAPTER 8

*Thermometers*

*Pressure gauges*



Thermometers					
Item no.	Description	Temperature	Closet	Approach	Price €
2800001	Thermometer	0 ... 120°C	63 mm	45 mm	8,67
2800005	Thermometer	0 ... 120°C	63 mm	100 mm	9,17
2800035	Thermometer	0 ... 120°C	80 mm	45 mm	9,37
2800002	Thermometer	0 ... 120°C	80 mm	63 mm	9,88
2800003	Thermometer	0 ... 120°C	100 mm	100 mm	13,23
2800004	Thermometer	0 ... 120°C	160 mm	150 mm	45,08
2800036	Thermometer	0 ... 60°C	100 mm	45 mm	15,83
2800037	Thermometer	0 ... 200°C	100 mm	100 mm	36,50



Pipe clamp thermometer					
Item no.	Description	Temperature	Closet	Connection	Price €
2800000	Thermometer clamp	0 ... 120°C	63 mm	Clamp band	13,53

Flue gas thermometers, made of stainless steel					
Item no.	Description	Temperature	Closet	Approach	Price €
2800006	Flue gas thermometer	0 ... 80°C	63 mm	300 mm	64,00
2800007	Flue gas thermometer	0 ... 500°C	63 mm	300 mm	54,59

Rod thermometers					
Item no.	Description	Temperature	Built-in	Connection	Price €
2800030	Rod thermometer	0 ... 120°C	Law	1/2"	61,09
2800031	Rod thermometer	0 ... 120°C	Perpendicular	1/2"	66,21
2800032	Rod thermometer	0 ... 120°C	Angled	1/2"	83,79
2800033	Rod thermometer	0 ... 60°C	Perpendicular	1/2"	66,21



Mano-thermometers					
Item no.	Description	Temperature	Closet	Connection	Price €
2800012	Mano-thermometer		80 mm	1/2" A	57,67

## MANOMETERS

Tube spring pressure gauges KL 1.6					
Item no.	Description	Closet	Pressure	Connection	Price €
2800023	Pressure gauge	60 mm	0 ... 1 bar	1/4" O	11,25
2800014	Pressure gauge	60 mm	0 ... 4 bar	1/4" O	9,92
2800015	Pressure gauge	60 mm	0 ... 4 bar	1/4" A	9,92
2800016	Pressure gauge	60 mm	0... 10 bar	1/4" O	9,92
2800017	Pressure gauge	100 mm	0 ... 4 bar	1/2" O	26,80
2800019	Pressure gauge	100 mm	0 ... 6 bar	1/2" O	26,80
2800020	Pressure gauge	100 mm	0... 10 bar	1/2" O	26,80
2800021	Pressure gauge	160 mm	0 ... 4 bar	1/2" O	64,73
2800022	Pressure gauge	160 mm	0 ... 1 bar	1/2" O	59,25



Glycerine Pressure Gauges					
Item no.	Description	Closet	Pressure	Connection	Price €
2800060	Pressure gauge	63 mm	0 ... 2.5 bar	1/4" O	18,20
2800061	Pressure gauge	63 mm	0 ... 40 bar	1/8" O	18,20
2800062	Pressure gauge	63 mm	0 ... 4 bar	1/4" O	18,20
2800063	Pressure gauge	63 mm	0 ... 10 bar	1/4" O	18,20
2800064	Pressure gauge	63 mm	- 1 ... 1.5 bar	1/4" O	18,20
2800065	Pressure gauge	63 mm	0 ... 2.5 bar	1/4" A	18,20
2800066	Pressure gauge	63 mm	0 ... 4 bar	1/4" A	18,20
2800067	Pressure gauge	63 mm	0 ... 10 bar	1/4" A	18,20
2800068	Pressure gauge	63 mm	- 1 ... 1.5 bar	1/4" A	18,20

Pressure gauges GAS version						
Item no.	Description	Closet	Pressure	Connection	Price €	
9600001	Pressure gauge	100 mm	0- 60 Mbar	1/2" O	89,84	
9600004	Pressure gauge	100 mm	0-250 Mbar	1/2" O	89,84	
9600006	Pressure gauge	100 mm	0-600 Mbar	1/2" O	89,84	
9600002	Pressure gauge	100 mm	0-400 Mbar	1/2" O	89,84	

## CHAPTER 9

*Weight safety devices*

*Gas filters*

*Gas pressure regulators*

*Spring safety devices*

## WEIGHT SAFETY DEVICES AND GAS FILTERS

### Bronze safety devices with indirect weight load.

By using a Teflon valve ring, this version is pre-eminently suitable for low-pressure steam up to 0.5 bar. Also suitable for hot water, air and non-hazardous gases up to 250°C. The weight safety devices are supplied complete with weight.

Material Specification:  
Bronze body, with interchangeable seal, cast iron weight.

Item no.	Description	Connection	Pressure	KG weight	Price €
3000001	Weight safety	1 1/4"	1,5 ... 4 bar	3,55KG	291,72
3000002	Weight safety	2"	0,5 ... 2 bar	3,55KG	497,54
3000003	Weight safety	2"	1,5 ... 4 bar	6,50KG	571,54



3000022	Weight for 1 1/4"		1,5 ... 4 bar	3,55KG	90,20
3000019	Weight for 2"		0,5 ... 2 bar	3,55KG	135,71
3000020	Weight for 2"		1,5 ... 4 bar	6,50KG	209,72

3000021	Teflon ring for weight safety 1 1/4"				11,58
3000004	Teflon ring for weight safety 2"				15,79

### Filters (dirt traps)

Filter is suitable for water, oil, compressed air and neutral gases.

Material Specification:

Mesh size : 0.25 mm  
Connection : female thread  
Home : bronze  
Maximum pressure : 16 bar

Also other mesh sizes available.

Item no.	Description	Facts	Connection size	Mesh size	Price €
3000010	Gas filter	Bronze	1/2"	0.25 mm	33,21
3000011	Gas filter	Bronze	3/4"	0.25 mm	38,25
3000012	Gas filter	Bronze	1"	0.25 mm	55,72
3000013	Gas filter	Bronze	1 1/4"	0.25 mm	82,90
3000014	Gas filter	Bronze	1 1/2"	0.25 mm	97,29
3000015	Gas filter	Bronze	2"	0.25 mm	168,26



### Filters, suitable for gas and water.

Filter is suitable for water and neutral gases.

Material Specification:

Flanges Ordinary: PN16  
Home : GG25

Other mesh size and passage on request.

A magnet is also available for this type of filter.

Item no.	Description	Connection size	mesh size	Price €
9619000	Gas/water filter	DN 50	0,75	146,20
9619001	Gas/water filter	DN 65	0,75	197,10
9619002	Gas/water filter	DN 80	1,20	252,00
9619004	Gas/water filter	DN 100	1,20	359,00
9619005	Gas/water filter	DN 125	1,20	529,20
9619006	Gas/water filter	DN 150	1,20	824,50
9619007	Gas/water filter	DN 200	1,20	1.607,60
9619009	Gas/water filter	DN 250	1,20	3.442,00



**Gas pressure regulators JEA VONS**

Specification: : female thread  
 Connection : 200 mbar  
 Max. pre-pressure : 22 ... 32 mbar  
 Output pressure adjustable

Item no.	Description	Type	Connection size	Price €
5200017	Gas pressure regulator	J 48	3/4"	156,18
5200018	Gas pressure regulator	J 48	1"	157,32
5200019	Gas pressure regulator	J 48	1 1/4"	224,58
5200020	Gas pressure regulator	J 48	1 1/2"	231,42
5200028	Gas pressure regulator	J 48	2"	306,66

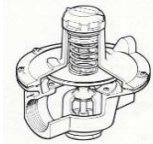

**Gas shortage protection JEA VONS**

Jaevons gas defect protection type J120 with Giveg approval.  
 Mechanically locked.

Specification: : female thread  
 Connection : 200 mbar  
 Max. pre-pressure : 15 mbar  
 Turning pressure

Item no.	Description	Type	Connection size	Note	Price €
5200013	Gas B valve	J 120	1"		289,56
5200014	Gas B valve	J 120	1 1/4"		364,80
5200015	Gas B valve	J 120	1 1/2"		371,64
5200016	Gas B valve	J 120	2"		555,18

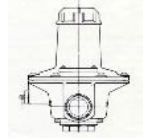

## RELIEF VALVES/SPRING SAFETY DEVICES

### Relief valves (bronze) not adjustable

Overflow valve for heating systems.

According to : TRD 721 DIN 4751 Part 2.

Max. temperature : 120°C

Glycol : max. 30 %

Home : bronze

### Relief valve without quality mark

Item no.	Description	Type	Connection size	Setting	Price €
3000025	Relief valve	651	1/2"	1.5 bar	46,21
3000026	Relief valve	651	1/2"	6 bar	28,25

### Relief valve with quality mark

Item no.	Description	Type	Connection size	Setting	Price €
3000006	Relief valve	651 HN	1/2"	3 bar	25,71
3000007	Relief valve	651 HN	3/4"	3 bar	35,67
3000008	Relief valve	651 HN	1"	3 bar	58,55
3000009	Relief valve	651 HN	1 1/4"	3 bar	121,16
3000023	Relief valve	651 HN	1 1/2"	3 bar	217,22
3000024	Relief valve	651 HN	2"	3 bar	330,99



### Safety valve, not adjustable

Flamco Prescor S safety valves for closed heating installations.

Equipped with lever to be able to lift the valve, as required by NEN3028.

Equipped with a type plate indicating the set pressure and boiler capacity.

It is not possible to change the setting pressure.

Body and valve seat : Brass

Connection : Female thread

Set pressure : 3 bar

Other adjustment pressures available on request.

Item no.	Description	Blow-off cap.	Inlet	Exhaust	Price €
3000030	Safety valve S700	810 KW	1 1/4"	1 1/2"	373,61
3000031	Safety valve S960	1120 KW	1 1/2"	2"	618,71
3000032	Safety valve S1700	1980 KW	2"	2 1/2"	710,36



### Spring safety devices

Suitable for oil and gases.

Resistant to : oil and gasoline

Max. Temperature : 618T, 225°C

: 619T, 130°C

: 618T, Teflon

Seals : 619T, perbunan

Home : bronze

Item no.	Description	Type	Connection size	Setting	Price €
3000027	Relief valve	618 T	1/2"	0.5 bar	111,68
3000018	Relief valve	619 E	3/4"	2 ... 12 bar	136,90

# CHAPTER 10

## *Greenhouse heating hose*

### *Viktor Chain*

#### *Supplies*





**ZANTINGH**

**Greenhouse heating hose and viktor chain, including supplies**

**GREENHOUSE HEATING HOSE AND HOSE COUPLINGS**

Kleber greenhouse heating hose					
Price per meter					
Item no.	Description	Connection size	Section	Weight	Price €
3100004	Heating hose Kledam	5/8"	16x24mm	335 gr/mtr.	7,83
3100005	Heating hose Kledam	3/4"	19x28mm	400 gr/mtr.	7,99
3100006	Heating hose Kledam	1"	25x33mm	603 gr/mtr.	12,13
3100009	Heating hose Kledam	5/4"	32x43mm	800 gr/mtr.	25,73
3100010	Heating hose Kledam	2"	50x64.5mm	1500 gr/mtr.	54,15

**HOSE CLAMP**

Item no.	Description	Connection size	Price €
3101102	Hose clamp Hi-grip size 22-30	for hose 19-28 (3/4")	0,85
3101103	Hose clamp Hi-grip size 25-35	for hose 25-33 (1")	0,83
3101105	Hose clamp Hi-grip size 35-50	for hose 32-43 (1 1/4")	1,15
3101106	Hose clamp Hi-grip size 50-70	for hose 50-64,5 (2")	1,36

**HOSE COUPLINGS**

Item no.	Description	Connection size	Price €
3102005	Astore coupling	25 X 25	3,95
3102008	Astore coupling	20 X 20	3,21
3102007	Astore coupling	20 X 1/2" Female thread	1,93
3102000	Astore coupling	25 X 3/4" external thread	1,86
3102001	Astore coupling	25 X 1/2" external thread	1,86
3102002	Astore coupling	20 X 1/2" external thread	1,72
3102003	Astore coupling	25 X 3/4" Female thread	2,16
3102004	Astore coupling	25 X 1/2" Female thread	2,16

**HOSE COUPLINGS**

Item no.	Description	Connection size	Price €
3103003	Geka coupling	1/2" external thread	2,35
3103005	Geka coupling	3/4" external thread	2,31
3103000	Geka coupling	1" external thread	2,48
3103001	Geka coupling	1 1/4" external thread	3,06
3103004	Geka coupling	1/2" Female thread	2,41
3103008	Geka coupling	3/4" Female thread	2,41
3103006	Geka coupling	1" Female thread	2,48
3103002	Geka coupling	1" Thule	3,04
3103007	Geka coupling blind		2,48

**HOSE COUPLINGS**



Item no.	Description	Connection size	Price €
3105005	Valvo coupling	25X1/2" Female thread	10,19
3105006	Valvo coupling	25X1/2" external thread	10,08
3105002	Valvo coupling	25X3/4" external thread	9,58
3105001	Valvo coupling	20X1/2"	6,95

**HOSE CLAMPS AND HOSE thules**

HOSE CLAMPS				
Item no.	Description	Connection size	Type	Price €
3101100	Hose clamp	13-20 mm	Hi-grip	0,79
3101101	Hose clamp	14- 22 mm	Hi-grip	0,90
3101102	Hose clamp	22- 30 mm	Hi-grip	0,85
3101103	Hose clamp	25- 35 mm	Hi-grip	0,83
3101104	Hose clamp	30-40 mm	Hi-grip	0,96
3101105	Hose clamp	35-50 mm	Hi-grip	1,15
3101111	Hose clamp	45- 50 mm	Hi-grip	1,24
3101106	Hose clamp	50-70 mm	Hi-grip	1,36
3101107	Hose clamp	60- 80 mm	Hi-grip	1,58
3101108	Hose clamp	70- 90 mm	Hi-grip	1,71
3101109	Hose clamp	80-100 mm	Hi-grip	1,83
3101110	Hose clamp	90-120 mm	Hi-grip	2,24
3101122	Hose clamp	22-30 mm	Hi-grip stainless	3,03
3101123	Hose clamp	30-40 mm	Hi-grip stainless steel	3,24



HOSE Thules				
Item no.	Description	Connection		Price €
3101016	Hose thule	1/2" X 50 mm		0,71
3101005	Hose thule	1/2" X 70 mm		0,75
3101015	Hose thule	3/4" X 50 mm		0,73
3101006	Hose thule	3/4" X 70 mm		0,79
3101031	Hose thule	1" X 50 mm		0,90
3101018	Hose thule	3/8" X 50 mm with wire		1,88
3101014	Hose thule	3/8" X 75 mm with wire		1,88
3101019	Hose thule	1/2" X 50 mm with wire		1,02
3101012	Hose thule	1/2" X 70 mm with wire		1,21
3101020	Hose thule	3/4" X 50 mm with wire		1,38
3101013	Hose thule	3/4" X 70 mm with wire		1,50
3101030	Hose thule	1" X 75 mm with wire		1,76
3101021	Hose thule	1/2" Curved		2,34
3101022	Hose thule	3/4" Curved		2,59
3101023	Welding plate with thule	51 mm with tulle 1/2X50		1,65
3101024	Welding plate with thule	51 mm with grommet 3/4X50		1,67
3101000	Hose Connection thule	1/2"		3,76

BRASS HOSE CONNECTORS				
Item no.	Description	Connection		Price €
6501006	Brass hose connector	20mm		2,81
6501007	Brass hose connector	25mm		4,01







**ZANTINGH**

**VIKTOR CHAIN and S-HOOKS**

<b>Viktor Chain</b>			
Viktor chain, delivery on 30-metre bunches, according to DIN 5686. Price per meter.			
Item no.	Description	Specification	Price €
4800006	Viktor chain	22 Gr. per meter	0,94
4800000	Viktor chain	27 Gr. per meter	1,18
4800001	Viktor chain	35 Gr. per meter	1,76
4800010	Viktor chain	50 Gr. per meter	3,02



<b>S-Hooks</b>			
Item no.	Description	Connection size	Price per 100 €
4800007	S-hooks	40 mm	12,66
4800002	S-hooks	50 mm	22,22
4800004	S-hooks	60 mm	42,10
4800005	S-hooks	70 mm	103,34
4800008	S-hooks	80 mm	133,80



# CHAPTER 11

*Flanges*

*Gaskets*

*Sealing materials*



<b>Welding FLANGES PN 6</b>				
Forged steel weld-on flanges, without rust protection.				
Facts	: DIN 2631			
Pressure stage	: PN 6			
Item no.	Description	DN	PN	Price €
3200001	Welding flange	DN 15/ 21.3	PN 6	7,26
3200003	Welding flange	DN 20/ 26.9	PN 6	4,14
3200004	Welding flange	DN 25/ 33.7	PN 6	5,41
3200005	Welding flange	DN 32/ 42.4	PN 6	7,77
3200006	Welding flange	DN 40/ 48.3	PN 6	7,83
3200042	Welding flange	DN 50/ 57.0	PN 6	7,49
3200007	Welding flange	DN 50/ 60.3	PN 6	8,72
3200008	Welding flange	DN 65/76	PN 6	9,83
3200009	Welding flange	DN 80/ 88.9	PN 6	15,94
3200010	Welding flange	DN 100/108	PN 6	22,30
3200035	Welding flange	DN 100/114.3	PN 6	18,85
3200011	Welding flange	DN 125/133	PN 6	30,00
3200039	Welding flange	DN 125/139.7	PN 6	25,77
3200012	Welding flange	DN 150/159	PN 6	30,45
3200040	Welding flange	DN 150/168.3	PN 6	30,45
3200014	Welding flange	DN 200/219.1	PN 6	49,00
3200045	Welding flange	DN 250/273	PN 6	75,70
3200049	Welding flange	DN 300/323.9	PN 6	87,13

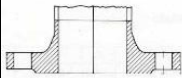

<b>Welding FLANGES PN 10</b>				
Forged steel weld-on flanges, without rust protection.				
Facts	: DIN 2632			
Pressure stage	: PN 10			
Item no.	Description	DN	PN	Price €
3200028	Welding flange	DN 200/219.1	PN 10	58,15
3200029	Welding flange	DN 250/273	PN 10	77,84
3200030	Welding flange	DN 300/323.9	PN 10	90,12
3200047	Welding flange	DN 350/355	PN 10	141,53
3200046	Welding flange	DN 400/406	PN 10	150,76
3200044	Welding flange	DN 500/508	PN 10	214,04

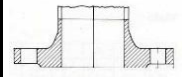

<b>Welding FLANGES PN 16</b>				
Forged steel weld-on flanges, without rust protection.				
Facts	: DIN 2633			
Pressure stage	: PN 16			
Item no.	Description	DN	PN	Price €
3200016	Welding flange	DN 15/ 21.3	PN 16	5,34
3200018	Welding flange	DN 25/ 33.7	PN 16	10,30
3200041	Welding flange	DN 32/ 38	PN 16	14,75
3200019	Welding flange	DN 32/ 42.4	PN 16	10,89
3200020	Welding flange	DN 40/ 48.3	PN 16	11,67
3200021	Welding flange	DN 50/ 60.3	PN 16	12,21
3200022	Welding flange	DN 65/ 76.1	PN 16	15,07
3200048	Welding flange	DN 65/ 76.1	PN 16	19,61
3200031	Welding flange	DN 80/ 88.9	PN 16	18,74
3200024	Welding flange	DN 100/108	PN 16	22,08
3200037	Welding flange	DN 100/114.3	PN 16	22,08
3200025	Welding flange	DN 125/133	PN 16	30,07
3200038	Welding flange	DN 125/139.7	PN 16	30,07
3200026	Welding flange	DN 150/159	PN 16	42,54
3200036	Welding flange	DN 150/168.3	PN 16	37,25
3200013	Welding flange	DN 175/193.7	PN 16	87,44
3200032	Welding flange	DN 200/219.1	PN 16	62,11
3200033	Welding flange	DN 250/273	PN 16	101,67
3200034	Welding flange	DN 300/323.9	PN 16	124,79
3200043	Welding flange	DN 400/406	PN 16	282,39

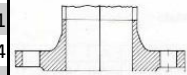

<b>Threaded flanges</b>				
Forged steel wire flanges, without rust protection.				
Facts	: DIN 2566			
Pressure stage	: PN 10/16			
Item no.	Description	Connection	Note	Price €
3201030	Threaded flange	1"		5,77
3201031	Threaded flange	1 1/4"		6,03
3201032	Threaded flange	1 1/2"		6,43
3201033	Threaded flange	2"		7,01
3201034	Threaded flange	2 1/2"		8,34
3201036	Threaded flange	3"	8 holes	10,61
3201037	Threaded flange	4"		12,29



<b>Blind flanges</b>				
Forged steel blind flanges, without rust protection.				
Facts	: DIN 2527			
Pressure stage	: PN 10/16			
Item no.	Description	Connection	Note	Price €
3201012	Blind flange	200 mm	ND 10	56,98
3201010	Blind flange	250 mm	ND 10	83,24
3201013	Blind flange	300 mm	ND 10	142,36
3201045	Blind flange	350 mm	ND 10	205,63
3201000	Blind flange	20 mm	ND 16	5,78
3201023	Blind flange	25 mm	ND 16	5,01
3201001	Blind flange	32 mm	ND 16	7,38
3201002	Blind flange	40 mm	ND 16	8,54
3201003	Blind flange	50 mm	ND 16	7,04
3201004	Blind flange	65 mm	ND 16	7,96
3201005	Blind flange	80 mm	ND 16	10,46
3201006	Blind flange	100 mm	ND 16	12,85
3201007	Blind flange	125 mm	ND 16	19,92
3201008	Blind flange	150 mm	ND 16	23,88
3201009	Blind flange	200 mm	ND 16	36,81
3201046	Blind flange	250 mm	ND 16	66,66
3201047	Blind flange	300 mm	ND 16	162,23

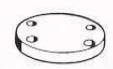

<b>Flat welding flanges</b>				
Forged steel welding flanges, without rust protection.				
Item no.	Description	Connection	Note	Price €
3201038	Flat welding flange	48.3 mm	4 holes	5,08
3201014	Flat welding flange	57.0 mm	4 holes	16,15
3201015	Flat welding flange	60.3 mm	4 holes	6,68
3201016	Flat welding flange	76.1 mm	4 holes	7,18
3201020	Flat welding flange	88.9 mm	8 holes	8,63
3201039	Flat welding flange	101.6 mm	4 holes	28,79
3201017	Flat welding flange	108.0 mm	8 holes	11,01
3201029	Flat welding flange	114.3 mm	8 holes	9,98
3201018	Flat welding flange	133.0 mm	8 holes	14,68
3201040	Flat welding flange	139.7 mm	8 holes	12,29
3201019	Flat welding flange	159.0 mm	8 holes	37,93
3201041	Flat welding flange	168.3 mm	8 holes	18,32
3201024	Flat welding flange	193.7 mm	8 holes	22,09
3201027	Flat welding flange	219.0 mm	8 holes	21,08
3201028	Flat welding flange	219.0 mm	12 holes	44,98
3201026	Flat welding flange	273.0 mm	12 holes	30,23
3201025	Flat welding flange	323.9 mm	12 holes	89,59
3201043	Flat welding flange	355.6 mm	16 holes	108,59



**GASKET SETS AND GROMMETS**

**Gasket Sets**

Gasket sets consisting of 2 Klinger gaskets. Including the number of nuts and bolts required.  
All this packed in 1 box.

Item no.	Description	Connection	Note	Price €
4901001	Gasket set	20 mm	ND 6	8,47
4901002	Gasket set	25 mm	ND 6	8,75
4901003	Gasket set	32 mm	ND 6	10,64
4901004	Gasket set	40 mm	ND 6	11,41
4901005	Gasket set	50 mm	ND 6	11,76
4901006	Gasket set	65 mm	ND 6	12,39
4901007	Gasket set	80 mm	ND 6	21,56
4901008	Gasket set	100 mm	ND 6	22,12
4901009	Gasket set	125 mm	ND 6	39,97
4901010	Gasket set	150 mm	ND 6	41,16
4901011	Gasket set	200 mm	ND 6	47,18
4901012	Gasket set	250 mm	ND 6	69,86

4901013	Gasket set	80 mm	ND 10	22,96
4901014	Gasket set	200 mm	ND 10	89,67
4901015	Gasket set	250 mm	ND 10	141,54

4901016	Gasket set	20 mm	ND 16	10,57
4901017	Gasket set	25 mm	ND 16	11,20
4901018	Gasket set	32 mm	ND 16	18,83
4901019	Gasket set	40 mm	ND 16	19,81
4901020	Gasket set	50 mm	ND 16	21,49
4901021	Gasket set	65 mm	ND 16	22,12
4901022	Gasket set	80 mm	ND 16	38,36
4901023	Gasket set	100 mm	ND 16	40,74
4901024	Gasket set	125 mm	ND 16	45,15
4901025	Gasket set	150 mm	ND 16	73,01
4901026	Gasket set	200 mm	ND 16	124,39
4901027	Gasket set	250 mm	ND 16	220,50

**Grommets Klinger ND 6**

Klinger SIL C4430 asbestos-free gaskets.  
The C4430 meets the requirements of BS7531 Grade X.

Item no.	Description	Type	Connection	Note	Price €
4900113	Flange Gasket	Koro HD	20 mm	ND 6	0,75
4900114	Flange Gasket	Koro HD	25 mm	ND 6	0,85
4900115	Flange Gasket	Koro HD	32 mm	ND 6	1,08
4900116	Flange Gasket	Koro HD	40 mm	ND 6	1,43
4900117	Flange Gasket	Koro HD	50 mm	ND 6	1,53
4900118	Flange Gasket	Koro HD	65 mm	ND 6	1,73
4900119	Flange Gasket	Koro HD	80 mm	ND 6	2,10
4900120	Flange Gasket	Koro HD	100 mm	ND 6	2,35
4900121	Flange Gasket	Koro HD	125 mm	ND 6	3,03
4900122	Flange Gasket	Koro HD	150 mm	ND 6	3,35
4900123	Flange Gasket	Koro HD	200 mm	ND 6	4,50
4900124	Flange Gasket	Koro HD	250 mm	ND 6	5,88
4900125	Flange Gasket	Koro HD	300 mm	ND 6	7,60

**Grommets Klinger ND 16**

Klinger SIL C4430 asbestos-free gaskets.  
The C4430 meets the requirements of BS7531 Grade X.

Item no.	Description	Type	Connection	Note	Price €
4900100	Flange Gasket	Koro HD	20 mm	ND 16	0,83
4900101	Flange Gasket	Koro HD	25 mm	ND 16	1,00
4900102	Flange Gasket	Koro HD	32 mm	ND 16	1,35
4900103	Flange Gasket	Koro HD	40 mm	ND 16	1,60
4900104	Flange Gasket	Koro HD	50 mm	ND 16	2,13
4900105	Flange Gasket	Koro HD	65 mm	ND 16	2,13
4900106	Flange Gasket	Koro HD	80 mm	ND 16	2,48
4900107	Flange Gasket	Koro HD	100 mm	ND 16	2,75
4900108	Flange Gasket	Koro HD	125 mm	ND 16	3,50
4900109	Flange Gasket	Koro HD	150 mm	ND 16	3,95
4900110	Flange Gasket	Koro HD	200 mm	ND 16	5,60
4900111	Flange Gasket	Koro HD	250 mm	ND 16	10,85
4900112	Flange Gasket	Koro HD	300 mm	ND 16	15,50

**Rubber grommets ND 6**

Klinger rubber gaskets SBR.

Item no.	Description	Type	Connection	Note	Price €
4900091	Flange Gasket	Rubber	15 mm	ND 6	0,30
4900018	Flange Gasket	Rubber	20 mm	ND 6	0,35
4900019	Flange Gasket	Rubber	25 mm	ND 6	0,48
4900020	Flange Gasket	Rubber	32 mm	ND 6	0,55
4900021	Flange Gasket	Rubber	40 mm	ND 6	0,73
4900022	Flange Gasket	Rubber	50 mm	ND 6	0,88
4900023	Flange Gasket	Rubber	65 mm	ND 6	1,08
4900024	Flange Gasket	Rubber	80 mm	ND 6	1,20
4900025	Flange Gasket	Rubber	100 mm	ND 6	1,35
4900026	Flange Gasket	Rubber	125 mm	ND 6	1,78
4900027	Flange Gasket	Rubber	150 mm	ND 6	1,90
4900029	Flange Gasket	Rubber	200 mm	ND 6	2,58
4900031	Flange Gasket	Rubber	250 mm	ND 6	4,50

**Rubber gaskets ND 10**

Item no.	Description	Type	Connection	Note	Price €
4900092	Flange Gasket	Rubber	15 mm	ND 10/16	0,38
4900093	Flange Gasket	Rubber	20 mm	ND 10/16	0,38
4900094	Flange Gasket	Rubber	25 mm	ND 10/16	0,53
4900032	Flange Gasket	Rubber	32 mm	ND 10/16	0,60
4900033	Flange Gasket	Rubber	40 mm	ND 10/16	0,73
4900034	Flange Gasket	Rubber	50 mm	ND 10/16	1,08
4900035	Flange Gasket	Rubber	65 mm	ND 10/16	1,33
4900036	Flange Gasket	Rubber	80 mm	ND 10/16	1,36
4900037	Flange Gasket	Rubber	100 mm	ND 10/16	1,50
4900038	Flange Gasket	Rubber	125 mm	ND 10/16	1,95
4900039	Flange Gasket	Rubber	150 mm	ND 10/16	2,10
4900041	Flange Gasket	Rubber	200 mm	ND 10/16	2,83
4900030	Flange Gasket	Rubber	250 mm	ND 10/16	3,65
4900095	Flange Gasket	Rubber	300 mm	ND 10/16	4,78
4900129	Flange Gasket	Rubber	350 mm	ND 10/16	34,50
4900127	Flange Gasket	Rubber	400 mm	ND 10/16	34,98

Gasket Plate						
Price per KG						
Item no.	Description	Type	Thickness	Note	Price €	
4900042	Gasket Plate	NR/SBR	3.0 mm	1m <sup>2</sup> = 4,5KG	13,15	

Graphite Gaskets						
Klinger asbestos-free graphite gaskets are made up of layers of flexible graphite with between a reinforcement of thin stainless steel or aluminum.						
Item no.	Description	Type	Connection	Note	Price €	
4900130	Flange Gasket	Graphite PSM	80 mm	ND 10	7,53	
4900131	Flange Gasket	Graphite PSM	100 mm	ND 10	8,05	
4900132	Flange Gasket	Graphite PSM	125 mm	ND 10	10,03	
4900133	Flange Gasket	Graphite PSM	150 mm	ND 10	11,35	
4900134	Flange Gasket	Graphite PSM	200 mm	ND 10	15,68	
4900135	Flange Gasket	Graphite PSM	250 mm	ND 10	20,35	
4900136	Flange Gasket	Graphite PSM	300 mm	ND 10	25,28	
4900137	Flange Gasket	Graphite PSM	350 mm	ND 10	52,95	

Item no.	Description	Connection	Pressure stage	Price €	
4900198	Flange insulation set	DN 50	PN10/16	105,23	
4900199	Flange insulation set	DN 65	PN10/16	120,90	
4900200	Flange insulation set	DN 80	PN10/16	125,32	
4900201	Flange insulation set	DN 100	PN10/16	194,57	
4900202	Flange insulation set	DN 125	PN10/16	259,05	
4900203	Flange insulation set	DN 150	PN10/16	259,05	
4900204	Flange insulation set	DN 200	PN10	296,66	

**MOUNTING MATERIALS**

<b>Hex bolts M12</b>				
Item no.	Description	Size		Price/100 pcs.
4300505	Hex bolt	M12 X 30	8.8 - Galvanized	27,15
4300507	Hex bolt	M12 X 40	8.8 - Galvanized	31,78
4300451	Hex bolt	M12 X 45	8.8 - Galvanized	40,51
4300452	Hex bolt	M12 X 50	8.8 - Galvanized	43,31
4300453	Hex bolt	M12 X 55	8.8 - Galvanized	47,24
4300454	Hex bolt	M12 X 60	8.8 - Galvanized	47,26
4300455	Hex bolt	M12 X 65	8.8 - Galvanized	49,82
4300456	Hex bolt	M12 X 70	8.8 - Galvanized	52,04
4300457	Hex bolt	M12 X 75	8.8 - Galvanized	59,68
4300458	Hex bolt	M12 X 80	8.8 - Galvanized	58,06
4300459	Hex bolt	M12 X 90	8.8 - Galvanized	64,21
4300460	Hex bolt	M12 X100	8.8 - Galvanized	70,66
4300461	Hex bolt	M12 X110	8.8 - Galvanized	80,35
4300462	Hex bolt	M12 X120	8.8 - Galvanized	93,56
4300463	Hex bolt	M12 X130	8.8 - Galvanized	101,25
4300464	Hex bolt	M12 X140	8.8 - Galvanized	105,98
4300465	Hex bolt	M12 X150	8.8 - Galvanized	114,46
4300516	Hex bolt	M12 X160	8.8 - Galvanized	131,08
4300060	Hex nut	M12	8.8 - Galvanized	7,34

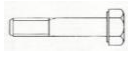

<b>Hex bolts M16</b>				
Item no.	Description	Size		Price/100 pcs.
4300466	Hex bolt	M16 X 50	8.8 - Galvanized	71,35
4300467	Hex bolt	M16 X 55	8.8 - Galvanized	77,14
4300468	Hex bolt	M16 X 60	8.8 - Galvanized	87,41
4300469	Hex bolt	M16 X 65	8.8 - Galvanized	97,13
4300470	Hex bolt	M16 X 70	8.8 - Galvanized	98,67
4300471	Hex bolt	M16 X 75	8.8 - Galvanized	112,94
4300472	Hex bolt	M16 X 80	8.8 - Galvanized	109,90
4300473	Hex bolt	M16 X 90	8.8 - Galvanized	121,26
4300474	Hex bolt	M16 X100	8.8 - Galvanized	131,96
4300475	Hex bolt	M16 X110	8.8 - Galvanized	155,19
4300476	Hex bolt	M16 X120	8.8 - Galvanized	165,92
4300477	Hex bolt	M16 X130	8.8 - Galvanized	176,85
4300478	Hex bolt	M16 X140	8.8 - Galvanized	192,10
4300479	Hex bolt	M16 X150	8.8 - Galvanized	206,65
4300510	Hex bolt	M16 X160	8.8 - Galvanized	237,67
4300512	Hex bolt	M16 X180	8.8 - Galvanized	285,41
4300515	Hex bolt	M16 X200	8.8 - Galvanized	292,24
4300061	Hex nut	M16	8.8 - Galvanized	14,27

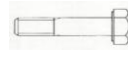

Hex bolts M20				
Item no.	Description	Size		Price/100 pcs.
4300480	Hex bolt	M20 X 60	8.8 - Galvanized	142,57
4300481	Hex bolt	M20 X 65	8.8 - Galvanized	178,57
4300482	Hex bolt	M20 X 70	8.8 - Galvanized	170,98
4300483	Hex bolt	M20 X 75	8.8 - Galvanized	192,05
4300484	Hex bolt	M20 X 80	8.8 - Galvanized	180,95
4300485	Hex bolt	M20 X 90	8.8 - Galvanized	198,33
4300486	Hex bolt	M20 X100	8.8 - Galvanized	215,94
4300487	Hex bolt	M20 X110	8.8 - Galvanized	251,63
4300488	Hex bolt	M20 X120	8.8 - Galvanized	263,93
4300489	Hex bolt	M20 X130	8.8 - Galvanized	287,43
4300490	Hex bolt	M20 X140	8.8 - Galvanized	305,55
4300491	Hex bolt	M20 X150	8.8 - Galvanized	328,75
4300509	Hex bolt	M20 X160	8.8 - Galvanized	373,88
4300514	Hex bolt	M20 X170	8.8 - Galvanized	487,78
4300511	Hex bolt	M20 X180	8.8 - Galvanized	425,12
4300508	Hex bolt	M20 X200	8.8 - Galvanized	492,16
4300062	Hex nut	M20	8.8 - Galvanized	27,88

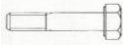

Hex bolts M24				
Item no.	Description	Size		Price/100 pcs.
4300492	Hex bolt	M24 X 70	8.8 - Galvanized	314,28
4300493	Hex bolt	M24 X 75	8.8 - Galvanized	319,44
4300494	Hex bolt	M24 X 80	8.8 - Galvanized	299,55
4300495	Hex bolt	M24 X 90	8.8 - Galvanized	328,24
4300496	Hex bolt	M24 X100	8.8 - Galvanized	355,06
4300497	Hex bolt	M24 X110	8.8 - Galvanized	408,97
4300498	Hex bolt	M24 X120	8.8 - Galvanized	426,56
4300499	Hex bolt	M24 X130	8.8 - Galvanized	439,87
4300500	Hex bolt	M24 X140	8.8 - Galvanized	476,91
4300501	Hex bolt	M24 X150	8.8 - Galvanized	517,11
4300502	Hex bolt	M24 X160	8.8 - Galvanized	597,36
4300503	Hex bolt	M24 X200	8.8 - Galvanized	788,25
4300154	Hex nut	M24	8.8 - Galvanized	64,29



Hex nuts				
Item no.	Description	Size		Price/100 pcs.
4300057	Hex nut	M6	8.8 - Galvanized	1,01
4300058	Hex nut	M8	8.8 - Galvanized	2,15
4300059	Hex nut	M10	8.8 - Galvanized	4,98
4300060	Hex nut	M12	8.8 - Galvanized	7,34
4300061	Hex nut	M16	8.8 - Galvanized	14,27
4300062	Hex nut	M20	8.8 - Galvanized	27,88
4300154	Hex nut	M24	8.8 - Galvanized	64,29



Washers				
Item no.	Description	Size		Price/100 pcs.
4302001	Washer	M6	Galvanized	1,19
4302002	Washer	M8	Galvanized	2,10
4302003	Washer	M10	Galvanized	3,90
4302004	Washer	M12	Galvanized	6,73
4302005	Washer	M16	Galvanized	12,02
4302006	Washer	M20	Galvanized	18,47
4302017	Washer	M24	Galvanized	29,85

Spring washers				
Item no.	Description	Size		Price/100 pcs.
4302013	Spring washer	M6	Galvanized	2,05
4302011	Spring washer	M8	Galvanized	2,96
4301997	Spring washer	M10	Galvanized	3,90
4301998	Spring washer	M12	Galvanized	5,39
4301999	Spring washer	M16	Galvanized	10,07
4302000	Spring washer	M20	Galvanized	17,43
4302015	Spring washer	M24	Galvanized	24,06

Threaded rod				
Item no.	Description	Size		Price/100 pcs.
4300072	Threaded rod	M6	4.6 - Galvanized 1 Mtr.	83,72
4300073	Threaded rod	M8	4.6 - Galvanized 1 Mtr.	124,45
4300074	Threaded rod	M10	4.6 - Galvanized 1 Mtr.	190,31
4300075	Threaded rod	M12	4.6 - Galvanized 1 Mtr.	268,23
4300076	Threaded rod	M16	4.6 - Galvanized 1 Mtr.	612,01
4300077	Threaded rod	M20	4.6 - Galvanized 1 Mtr.	908,35
4300078	Threaded rod	M24	4.6 - Galvanized 1 Mtr.	1.368,93

Other sizes on request.

## CHAPTER 12

*Oil Heating Materials*

*Syphons and sight glasses*

*Aerators, air vents*

*Tapes and pipe protection materials*

*Low-water protections*

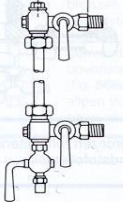

## SIGHT GLASS DEVICES AND SYPHONS

Sight glass devices						
Item no.	Description	Connection size	Note		Price €	
5600000	Pressure gauge tap	1/2"			79,84	
5600001	Needle valve	3/8"			25,25	
5600002	Needle valve	1/2"			28,45	
5600003	Sight glass knee	1/2"			On request	
5700013	Perspex sight glass protector		2.0 meters		353,15	
5700023	Protective cap holder + gland				83,03	
5600013	Rubber ring for sight glass device				2,61	
5600004	Brass sight glass device	1/2"			209,33	
5600012	Sight glass	Plastic	13/9 mm	2.0 meters	50,21	
5600009	Sight glass		12/13 mm	1.5 meters	3,14	
5600010	Sight glass		12/13 mm	2.0 meters	7,12	
5600008	Rubber ring for sight glass knee				On request	

Syphons				
Item no.	Description	Connection		Price €
5600005	Syphon	1/4"		49,14
5600006	Syphon	3/8"		43,68
5600007	Syphon	1/2"		21,29

## AERATORS, AIR VENTS, FILLING AND DRAIN VALVES

Hand air vents					
Item no.	Description	Connection	Note		Price €
5700000	Air vent	1/4"	Brass		1,25
5700001	Air vent	1/4"	Brass	With tube	1,35

Aerators / Air Vents	
Maximum system pressure	: 16 bar
Maximum differential pressure	: 14 bar
Maximum temperature	: 127°C

Item no.	Description	Type	Connection size	Connection	Price €
5700006	BE air vent	Spirax AE14E	1/2" BSP	thread	617,89

Automatic float air vent	
Air vent with built-in shut-off valve to allow parts to be replaced or cleaned without draining the system.	
Maximum system pressure	: 12 bar
Maximum temperature	: 110°C

Item no.	Description	Type	Connection size	Connection	Price €
5700003	Automatic air vent	Minivali 12103	3/8"	Wire	9,72

Automatic float air vent					
Item no.	Description	Type	Connection size	Connection	Price €
5700029	Automatic air vent	Tuxhorn 559	3/8"	Wire	61,36

Automatic quick air vent	
Air vent with built-in shut-off valve.	
Maximum system pressure	: 6 bar
Maximum temperature	: 110°C

Item no.	Description	Type	Connection size	Connection	Price €
5700016	Automatic air vent	Spirotop	1/2" X 1/2"	Wire	79,23
5700028	Automatic air vent	Flexvent Super	1/2"	Wire	80,84

## Vacuum protectors PRESSCON

Ideally suited for securing horizontal buffer tanks against vacuum.

### Technical data:

Material	: stainless steel 304
Continuous workload	: 1.5 bar
Maximum peak pressure	: 3.0 bar
Maximum temperature	: 120°C.
Vacuum opening pressure	: 2 ... 5 mbar

Vacuum over- and working pressure protectors are also available for vertical buffer tanks.

Item no.	Description	Type	Connection size	Price €
3050001	Vacuum protector	PV50-2	DN 50 ND10 flange	1.670,90
3050002	Vacuum protector	PV80-2	DN 80 ND6 flange	1.774,91
3050005	Vacuum protector	PV100-2	DN 100 ND6 flange	2.333,78



## LOW WATER PROTECTION

### Low water protection

Item no.	Description	Type	Connection	Price €
9980108	Low water security guard	SYR 933.1	3/4" Coupling	562,62
9980109	Low water security guard	SYR 932.5	2" Screw Short	471,18
9980110	Low water security guard	SYR 932.1	2" Screw Long	716,00

## AIR PRESSURE SWITCHES

### Air pressure switch

Item no.	Description	Type	Range	Price €
9603043	Pressure switch	GW 3 – A6	0,4 ... 3 mbar	72,00
9603046	Pressure switch	GW 10 – A6	1,0 ... 10 mbar	69,00
9603044	Pressure switch	GW 50 – A6	2,5 ... 50 mbar	69,00
9603045	Pressure switch	GW 150 – A6	30 ... 150 mbar	69,00
9603047	Connection plug pressure switch		4 pole (3+E)	4,14



Densole tape and accessories							
Item no.	Description	Type	Width/volume	Note	Price €		
5702005	Denso kit	DENSIT-KITT WS	0.5 kg	per bar	20,48		
5500031	Densolene primer	HT	1 Liter	by bus	52,08		
5702019	Densole band	AS 40 Yellow	50 mm wide	15 m. per roll	53,92		
5702020	Densole band	AS 40 Yellow	100 mm wide	15 m. per roll	104,64		
5702018	Densole band	S10	50 mm wide	15 m. per roll	46,84		
5702008	Densole band	S40	30 mm wide	15 m. per roll	32,88		
5702006	Densole band	AS40 Plus black.	50 mm wide	15 m. per roll	53,92		
5702007	Densole band	AS40 Plus black.	100 mm wide	15 m. per roll	104,64		
5702009	Tar Belt		100 mm	per roll	34,00		
5702003	Fat band		100 mm	per roll	26,04		
5702000	Aluminum adhesive tape		50 mm	per roll	11,17		
5702001	Aluminum adhesive tape		75 mm	per roll	16,77		
5702002	Aluminum adhesive tape		100 mm	per roll	On request		
5702013	Adhesive tape foil	Yellow	50 mm	10 m. per roll	2,19		
5702014	Adhesive tape foil	Yellow	100 mm	10 m. per roll	On request		
5702004	Gas marking tape	Yellow	40 mm	per roll	On request		

Tape and thread seals							
Item no.	Description	Type	Width/volume	Note	Price €		
5702017	Tape Gastec QA Approval Class 0.2		12 mm	12 m. per roll	1,20		
5702015	Tape unapproved white		12 mm	12 m. per roll	1,00		
5500083	Hemp bun		200 gr.		8,42		
5500005	Fitterskit / sealing paste		400 ml	per jar	11,07		
5500032	Loctite	570	50 ml	per tube	38,86		
5500033	Loctite	570	250 ml	per tube	158,91		
5500001	Permabond tube	A131(Gastec QA)	200 ml	per tube	88,25		

Boiler masonry				
Item no.	Description	Type	Weight	Price €
5500006	Calde-plast F30AB	(Plibrico)	25 kg	65,25
5500007	Calde-plast MW	Strong-lite	25 kg	53,19

Aerosol cans					
Item no.	Description	Type	Note	Price	Price €
5500010	Zinc spray	Spray 80/81	400 ml	per aerosol can	21,22
5500037	Gas leak detector		400 ml	per aerosol can	8,74

**Home heating accessories**

**Relief valve**

Item no.	Description	Type	Connection size	Price €
5500025	Relief valve	3 Bar	1/2" Bi.	22,20
5500026	Relief valve	3 Bar	1/2" Bu.	23,54



**Relief valve**

Item no.	Description	Connection size	Connection	Price €
5500009	Inlet combination	15 mm	Squeeze	23,64
5500004	Inlet combination	15 mm	Solder	30,65



Item no.	Description	Connection size	Price €
5701007	Ballofix	1/2" bi. X 1/2" bu.	13,30
5701008	Ballofix	1/4" bi. X 1/4" bu.	11,78
5701009	Ballofix	3/8" bi. X 3/8" bu.	7,08

**Relief valve**

Item no.	Description	Type	Note	Connection size	Price €
5701003	Fill and drain valve	Bullet		1/2"	6,00
5701005	Fill and drain valve	Bullet		3/4"	15,18
5701004	Key filling and draining valve			1/2"	1,12

Item no.	Description	Type	Connection size	Price €
5500014	Radiator plug	Simplex	1/2"	0,98
5500017	Radiator drain	Simplex	1/2"	10,00
5500018	Drain rotatable	Simplex		3,02
5500019	Plug with air vent	Simplex	1/2"	3,89
5500020	Ball filling drain valve	Law	1/2"	19,17

Item no.	Description	Type	Connection size	Price €
5700002	Vent valve		1/8"	0,94
5700005	Key bleed valve			0,35

**Relief valve**

Item no.	Description	Type	Price €
5500057	Plastic plug	U 6	0,07
5500090	Plastic plug	U 8	0,09
5500058	Plastic plug	U 10	0,17

Item no.	Description	Connection	Price €
5500080	Boil-dry protection	1/8" - 1/2"	18,96

# CHAPTER 13

*Fan heaters, indirect fired*

**Fan heaters**

**Indirectly fired fan heater**  
 Can be used where a room needs to be heated, suitable for wall and ceiling mounting.  
 Casing made of galvanized and sprayed profile frame construction.  
 Removable casing plates, galvanized.  
 Noiseless motor with built-in thermal contacts for motor protection, 230V, 400V, explosion-proof version.  
 Heat exchanger made of Cu/Al, suitable for hot water, hot water up to PN 16, 180°C.  
 Suitable for steam up to 9 bar  
 Alternatively galvanized steel.

Item no.	Description	Type	Price €
6710001	Indirectly fired fan heater	LH 25-2	922,78
6710002	Indirectly fired fan heater	LH 25-3	964,60
6710003	Indirectly fired fan heater	LH 25-4	1.041,64
6710005	Indirectly fired fan heater	LH 40-2	1.158,96
6710006	Indirectly fired fan heater	LH 40-3	1.291,11
6710007	Indirectly fired fan heater	LH 40-4	1.413,78
6710009	Indirectly fired fan heater	LH 63-2	1.599,90
6710010	Indirectly fired fan heater	LH 63-3	1.662,63
6710011	Indirectly fired fan heater	LH 63-4	1.920,33
6710013	Indirectly fired fan heater	LH 100-2	2.133,95
6710014	Indirectly fired fan heater	LH 100-3	2.408,66
6710015	Indirectly fired fan heater	LH 100-4	2.680,06
6710016	Wide spout	LH 25	175,72
6710017	Wide spout	LH 40	210,33
6710018	Wide spout	LH 63	306,12
6710019	Wide spout	LH 100	394,28
6710020	Four-sided outlet for	LH 25	196,63
6710021	Four-sided outlet for	LH 40	213,11
6710022	Four-sided outlet for	LH 63	250,00
6710023	Four-sided outlet for	LH 100	279,75
6710024	Contents per set for.	LH 25/40	71,59
6710026	Contents per set for.	LH 63/100	79,52
6710028	Speed Regulator DS 4KW 2STD 400V LH		332,07
6710029	Room thermostat for LH		60,87
6710031	Suspension bracket for LH		11,74
6710032	5-position switch D5-3		577,52



# CHAPTER 14

## *SPX pumps*



<b>CombiLine 230/400V 3 phase 50Hz 4-pole</b>			
Item no.	Description	Art.nr. SPX	Price €
2010051	CL32-125 0.13kW 230/400 50H	5.1919.01.11	991,12
2010090	CL40C-125 0.13kW 230/400 50H	5.1901.01.61	1.128,76
2010091	CL40C-125 0.18kW 230/400 50H	5.1901.01.62	1.165,48
2010092	CL40C-125 0.25kW 230/400 50H	5.1901.01.51	1.232,76
2010093	CL40C-125 0.37kW 230/400 50H	5.1901.01.52	1.274,39
2010002	CL40-160 0.25kW 230/400 50H	5.1902.01.01	1.365,84
2010003	CL40-160 0.37kW 230/400 50H	5.1902.01.02	1.407,12
2010004	CL40-160 0.55kW 230/400 50H	5.1902.01.03	1.443,83
2010005	CL40-200 0.55kW 230/400 50H	5.1903.01.03	1.514,21
2010006	CL40-200 0.75kW 230/400 50H	5.1903.01.04	1.560,07
2023015	CL40-200 1.1k 230/400 50H4	5.1903.01.05	1.632,57
2010008	CL50-125 0.25kW 230/400 50H	5.1904.01.01	1.420,91
2010009	CL50-125 0.37kW 230/400 50H	5.1904.01.02	1.457,61
2010010	CL50-160 0.25kW 230/400 50H	5.1905.01.01	1.546,00
2010011	CL50-160 0.37kW 230/400 50H	5.1905.01.02	1.581,49
2010012	CL50-160 0.55kW 230/400 50H	5.1905.01.03	1.636,55
2026015	CL50-160 0.75k 230/400 50H4	5.1905.01.04	1.670,12
2010014	CL50-200 0.75kW 230/400 50H	5.1906.01.04	1.792,53
2010015	CL50-200 1.1kW 230/400 50H	5.1906.01.05	1.858,33
2026025	CL50-200 1.5k 230/400 50H4	5.1906.01.06	1.925,01
2010017	CL65-125 0.25kW 230/400 50H	5.1907.01.01	1.566,18
2010018	CL65-125 0.37kW 230/400 50H	5.1907.01.02	1.596,78
2010019	CL65-125 0.55kW 230/400 50H	5.1907.01.03	1.644,22
2010021	CL65-160 0.55kW 230/400 50H	5.1908.01.03	1.800,21
2010022	CL65-160 0.75kW 230/400 50H	5.1908.01.04	1.826,21
2010023	CL65-160 1.1kW 230/400 50H	5.1908.01.05	1.899,64
2010024	CL65-200 1.1kW 230/400 50H	5.1909.01.05	1.974,59
2010025	CL65-200 1.5kW 230/400 50H	5.1909.01.06	2.041,87
2027024	CL65-200 2.2k 400/690 50H4	5.1909.01.07	2.354,29
2010027	CL80-125 0.55kW 230/400 50H	5.1910.01.03	1.745,13
2010028	CL80-125 0.75kW 230/400 50H	5.1910.01.04	1.821,61
2010029	CL80-125 1.1kW 230/400 50H	5.1910.01.05	1.904,22
2010030	CL80-160 1.1kW 230/400 50H	5.1911.01.05	2.037,27
2010031	CL80-160 1.5kW 230/400 50H	5.1911.01.06	2.089,29
2010032	CL80-160 2.2kW 400/690 50H	5.1911.01.07	2.182,57
2010033	CL80-200 1.5kW 230/400 50H	5.1912.01.06	2.349,31
2010034	CL80-200 2.2kW 400/690 50H	5.1912.01.07	2.597,07
2010035	CL80-200 3kW 400/690 50H	5.1912.01.08	2.724,04
2029024	CL80A-250 4k 400/690 50H4	5.1921.01.09	4.940,23
2029029	CL80A-250 5.5k 400/690 50H4	5.1921.01.13	5.452,63
2010500	CL80A-250 7.5kW 400/690 50H	5.1921.01.14	5.818,18
2010501	CL80A-250 9.2kW 400/690 50H	5.1921.01.15	6.348,88
2029003	CL80A-250 11k 400/690 50H4	5.1921.01.16	6.598,20
2010036	CL100-150 0.75kW 230/400 50H	5.1913.01.04	1.956,21
2010037	CL100-150 1.1kW 230/400 50H	5.1913.01.05	2.083,16
2010038	CL100-150 1.5kW 230/400 50H	5.1913.01.06	2.278,94

Item no.	Description	Art.nr. SPX	Price €
2010039	CL100-160 1.5kW 230/400 50H	5.1914.01.06	2.575,67
2010040	CL100-160 2.2kW 400/690 50H	5.1914.01.07	2.746,97
2010041	CL100-160 3kW 400/690 50H	5.1914.01.08	2.858,63
2010048	CL100-200 2.2kW 400/690 50H	5.1920.01.07	3.135,44
2010049	CL100-200 3kW 400/690 50H	5.1920.01.08	3.335,85
2010050	CL100-200 4kW 400/690 50H	5.1920.01.09	3.580,51
2013039	CL100-200 5.5k 400/690 50H4	5.1920.01.13	4.481,41
2010056	CL100-200 7.5kW 400/690 50H	5.1920.01.14	4.914,24
2014030	CL100A-250 5.5k 400/690 50H4	5.1922.01.13	5.717,22
2010503	CL100A-250 7.5kW 400/690 50H	5.1922.01.14	6.050,62
2014038	CL100A-250 9.2k 400/690 50H4	5.1922.01.15	6.579,83
2014003	CL100A-250 11k 400/690 50H4	5.1922.01.16	6.852,09
2010502	CL100A-250 15kW 400/690 50H	5.1922.01.17	7.658,13
2010042	CL125-160 2.2kW 400/690 50H	5.1915.01.07	3.634,04
2010043	CL125-160 3kW 400/690 50H	5.1915.01.08	3.845,14
2010044	CL125-160 4kW 400/690 50H	5.1915.01.09	4.100,55
2010508	CL125-160 5.5kW 400/690 50H	5.1915.01.13	4.608,34
2015022	CL125-160 7.5k 400/690 50H4	5.1915.01.14	5.002,96
2010509	CL125C-200 4kW 400/690 50H	5.1923.01.69	4.245,86
2010058	CL125C-200 5.5kW 400/690 50H	5.1923.01.63	4.755,18
2010059	CL125C-200 7.5kW 400/690 50H	5.1923.01.64	5.148,25
2016027	CL125A-250 7.5k 400/690 50H4	5.1924.01.14	6.662,42
2010505	CL125A-250 9.2kW 400/690 50H	5.1924.01.15	7.220,70
2010504	CL125A-250 11kW 400/690 50H	5.1924.01.16	7.486,83
2016001	CL125A-250 15k 400/690 50H4	5.1924.01.17	8.360,17
2010060	CL150-125 2.2kW 400/690 50H	5.1929.01.07	5.486,25
2018002	CL150-125 3k 400/690 50H4	5.1929.01.08	5.698,88
2018004	CL150-125 4k 400/690 50H4	5.1929.01.09	6.015,49
2010061	CL150-160 4kW 400/690 50H	5.1925.01.09	5.998,65
2010063	CL150-160 5.5kW 400/690 50H	5.1925.01.13	6.706,80
2018025	CL150-160 7.5k 400/690 50H4	5.1925.01.14	7.145,76
2018052	CL150-200 4k 400/690 50H4	5.1926.01.09	6.255,58
2010065	CL150-200 5.5kW 400/690 50H	5.1926.01.13	6.963,77
2010066	CL150-200 7.5kW 400/690 50H	5.1926.01.14	7.407,31
2010067	CL150-200 9.2kW 400/690 50H	5.1926.01.15	7.964,04
2018067	CL150-250 11k 400/690 50H4	5.1927.01.16	8.617,13
2010068	CL150-250 15kW 400/690 50H	5.1927.01.17	9.254,91
2010077	CL150-250 18.5kW 400/690 50H	5.1927.01.18	10.201,66
2010069	CL150-250 22kW 400/690 50H	5.1927.01.19	10.626,85
2019021	CL200-200 9.2k 400/690 50H4	5.1928.01.15	7.968,59
2010072	CL200-200 11kW 400/690 50H	5.1928.01.16	8.234,75
2010073	CL200-200 15kW 400/690 50H	5.1928.01.17	9.126,44

Item no.	Description	Art.nr. SPX	Price €
2010074	CL4/4 0.26kW 230 50H	5.1990.01.03	825,91
2010052	CL4/4 0.13kW 230/400 50H	5.1990.01.01	795,35
2010053	CL4/4 0.26kW 230/400 50H	5.1990.01.02	825,93
2010054	CL4/4 0.13kW 230/400 50H	5.1991.01.01	795,24
2010055	CL4/4 0.26kW 230/400 50H	5.1991.01.02	825,93

<b>CombiLine 230/400V 3 phase 50Hz 6-pole</b>			
Item no.	Description	Art.nr. SPX	Price €
2029000	CL80A-250 1.5k 230/400 50H6	5.1921.02.06	4.695,52
2029013	CL80A-250 2.2k 400/690 50H6	5.1921.02.07	5.009,08
2029017	CL80A-250 3k 400/690 50H6	5.1921.02.08	5.339,46
2013018	CL100-200 1.5k 230/400 50H6	5.1920.02.06	3.881,84
2013024	CL100-200 2.2k 400/690 50H6	5.1920.02.07	4.193,85
2014000	CL100A-250 1.5k 230/400 50H6	5.1922.02.06	5.269,07
2014013	CL100A-250 2.2k 400/690 50H6	5.1922.02.07	5.582,63
2014019	CL100A-250 3k 400/690 50H6	5.1922.02.08	5.893,11
2014023	CL100A-250 4k 400/690 50H6	5.1922.02.09	6.266,32
2010507	CL125-160 1.5kW 230/400 50H	5.1915.02.06	4.377,39
2015006	CL125-160 2.2k 400/690 50H6	5.1915.02.07	4.690,95
2017000	CL125C-200 1.5k 230/400 50H6	5.1923.02.56	4.522,70
2010078	CL125C-200 2.2kW 400/690 50H	5.1923.02.57	4.836,23
2016008	CL125A-250 2.2k 400/690 50H6	5.1924.02.07	5.943,56
2016014	CL125A-250 3k 400/690 50H6	5.1924.02.08	6.241,82
2016017	CL125A-250 4k 400/690 50H6	5.1924.02.09	6.679,26
2018007	CL150-160 1.5k 230/400 50H6	5.1925.02.06	6.024,66
2018013	CL150-160 2.2k 400/690 50H6	5.1925.02.07	6.266,32
2018032	CL150-200 1.5k 230/400 50H6	5.1926.02.06	6.204,93
2010064	CL150-200 2.2kW 400/690 50H	5.1926.02.07	6.527,84
2018045	CL150-200 3k 400/690 50H6	5.1926.02.08	6.827,62
2018077	CL150-250 3k 400/690 50H6	5.1927.02.08	7.301,78
2010070	CL150-250 4kW 400/690 50H	5.1927.02.09	7.573,99
2018082	CL150-250 5.5k 400/690 50H6	5.1927.02.13	7.898,27
2010071	CL200-200 3kW 400/690 50H	5.1928.02.08	6.982,11
2019011	CL200-200 4k 400/690 50H6	5.1928.02.09	7.416,50
2019014	CL200-200 5.5k 400/690 50H6	5.1928.02.13	7.743,79

<b>CombiLine 460/480V 3 phase 60Hz 4-pole</b>			
Item no.	Description	Art.nr. SPX	Price €
2022001	CL4/4 0.13k 277/480 60H4	5.1990.71.01	929,49
2022005	CL4/4 0.26k 277/480 60H2	5.1990.71.02	960,07
2025001	CL5/4 0.13k 277/480 60H4	5.1991.71.01	929,38
2025005	CL5/4 0.26k 277/480 60H2	5.1991.71.02	960,07
2021001	CL32-125 0.13k 277/480 60H4	5.1919.71.11	1.125,26
2024001	CL40C-125 0.13k 277/480 60H4	5.1901.71.61	1.262,92
2024004	CL40C-125 0.18k 277/480 60H4	5.1901.71.62	1.299,61
2024007	CL40C-125 0.25k 277/480 60H4	5.1901.71.51	1.366,90
2024010	CL40C-125 0.37k 277/480 60H4	5.1901.71.52	1.408,54
2023001	CL40-160 0.25k 277/480 60H4	5.1902.71.01	1.499,98
2023004	CL40-160 0.37k 277/480 60H4	5.1902.71.02	1.541,26
2023007	CL40-160 0.55k 277/480 60H4	5.1902.71.03	1.577,99
2023010	CL40-200 0.55k 277/480 60H4	5.1903.71.03	1.648,34
2023013	CL40-200 0.75k 277/480 60H4	5.1903.71.04	1.694,21
2023017	CL40-200 1.1k 277/480 60H4	5.1903.71.05	1.766,72
2026001	CL50-125 0.25k 277/480 60H4	5.1904.71.01	1.555,05
2026004	CL50-125 0.37k 277/480 60H4	5.1904.71.02	1.591,76
2026007	CL50-160 0.25k 277/480 60H4	5.1905.71.01	1.680,14
2026010	CL50-160 0.37k 277/480 60H4	5.1905.71.02	1.715,66
2026013	CL50-160 0.55k 277/480 60H4	5.1905.71.03	1.770,69
2026017	CL50-160 0.75k 277/480 60H4	5.1905.71.04	1.804,27
2026020	CL50-200 0.75k 277/480 60H4	5.1906.71.04	1.926,68
2026023	CL50-200 1.1k 277/480 60H4	5.1906.71.05	1.992,48
2026027	CL50-200 1.5k 277/480 60H4	5.1906.71.06	2.059,16
2027001	CL65-125 0.25k 277/480 60H4	5.1907.71.01	1.700,34
2027004	CL65-125 0.37k 277/480 60H4	5.1907.71.02	1.730,94
2027007	CL65-125 0.55k 277/480 60H4	5.1907.71.03	1.778,36
2027010	CL65-160 0.55k 277/480 60H4	5.1908.71.03	1.934,36
2027013	CL65-160 0.75k 277/480 60H4	5.1908.71.04	1.960,36
2027016	CL65-160 1.1k 277/480 60H4	5.1908.71.05	2.033,79
2027019	CL65-200 1.1k 277/480 60H4	5.1909.71.05	2.108,73
2027022	CL65-200 1.5k 277/480 60H4	5.1909.71.06	2.176,02
2027026	CL65-200 2.2k 277/480 60H4	5.1909.71.07	2.488,43
2028001	CL80-125 0.55k 277/480 60H4	5.1910.71.03	1.879,29
2028004	CL80-125 0.75k 277/480 60H4	5.1910.71.04	1.955,77
2028007	CL80-125 1.1k 277/480 60H4	5.1910.71.05	2.038,36
2028010	CL80-160 1.1k 277/480 60H4	5.1911.71.05	2.171,42
2028013	CL80-160 1.5k 277/480 60H4	5.1911.71.06	2.223,44
2028016	CL80-160 2.2k 277/480 60H4	5.1911.71.07	2.316,72
2028019	CL80-200 1.5k 277/480 60H4	5.1912.71.06	2.483,44
2028022	CL80-200 2.2k 277/480 60H4	5.1912.71.07	2.731,22
2028025	CL80-200 3k 460/800 60H4	5.1912.71.08	2.858,17

Item no.	Description	Art.nr. SPX	Price €
2029032	CL80A-250 7.5k 460/800 60H4	5.1921.71.14	5.952,32
2029035	CL80A-250 9.2k 460/800 60H4	5.1921.71.15	6.483,04
2029005	CL80A-250 11k 460/800 60H4	5.1921.71.16	6.732,34
2029008	CL80A-250 15k 460/800 60H4	5.1921.71.17	7.481,81
2029011	CL80A-250 18.5k 460/800 60H4	5.1921.71.18	8.397,95
2013001	CL100-150 0.75k 277/480 60H4	5.1913.71.04	2.090,36
2013004	CL100-150 1.1k 277/480 60H4	5.1913.71.05	2.217,31
2013007	CL100-150 1.5k 277/480 60H4	5.1913.71.06	2.413,08
2013010	CL100-160 1.5k 277/480 60H4	5.1914.71.06	2.709,81
2013013	CL100-160 2.2k 277/480 60H4	5.1914.71.07	2.881,11
2013016	CL100-160 3k 460/800 60H4	5.1914.71.08	2.992,78
2013028	CL100-200 2.2k 277/480 60H4	5.1920.71.07	3.269,59
2013034	CL100-200 3k 460/800 60H4	5.1920.71.08	3.469,99
2013037	CL100-200 4k 460/800 60H4	5.1920.71.09	3.714,66
2013041	CL100-200 5.5k 460/800 60H4	5.1920.71.13	4.615,56
2013044	CL100-200 7.5k 460/800 60H4	5.1920.71.14	5.048,38
2013022	CL100-200 11k 460/800 60H4	5.1920.71.16	5.874,15
2014032	CL100A-250 5.5k 460/800 60H4	5.1922.71.13	5.851,37
2014037	CL100A-250 7.5k 460/800 60H4	5.1922.71.14	6.184,79
2014040	CL100A-250 9.2k 460/800 60H4	5.1922.71.15	6.713,98
2014005	CL100A-250 11k 460/800 60H4	5.1922.71.16	6.986,24
2014008	CL100A-250 15k 460/800 60H4	5.1922.71.17	7.792,28
2014011	CL100A-250 18.5k 460/800 60H4	5.1922.71.18	8.709,97
2014017	CL100A-250 22k 460/800 60H4	5.1922.71.19	9.907,56
2015011	CL125-160 2.2k 277/480 60H4	5.1915.71.07	3.768,20
2015014	CL125-160 3k 460/800 60H4	5.1915.71.08	3.979,30
2015017	CL125-160 4k 460/800 60H4	5.1915.71.09	4.234,71
2015020	CL125-160 5.5k 460/800 60H4	5.1915.71.13	4.742,49
2015024	CL125-160 7.5k 460/800 60H4	5.1915.71.14	5.137,11
2015004	CL125-160 11k 460/800 60H4	5.1915.71.16	5.408,69
2017017	CL125C-200 5.5k 460/800 60H4	5.1923.71.63	4.889,32
2017020	CL125C-200 7.5k 460/800 60H4	5.1923.71.64	5.282,41
2010510	CL125C-200 9.2kW 460/800 60H	5.1923.71.65	5.813,14
2017004	CL125C-200 11k 460/800 60H4	5.1923.71.66	6.622,21
2017015	CL125C-200 4k 460/800 60H4	5.1923.71.69	4.380,01
2016000	CL125A-250 11k 460/800 60H4	5.1924.71.16	7.620,98
2016003	CL125A-250 15k 460/800 60H4	5.1924.71.17	8.494,32
2016006	CL125A-250 18.5k 460/800 60H4	5.1924.71.18	9.410,50
2016012	CL125A-250 22k 460/800 60H4	5.1924.71.19	9.829,56
2018006	CL150-125 4.0k 460/800 60H4	5.1929.71.09	6.149,63
2018027	CL150-160 7.5k 460/800 60H4	5.1925.71.14	7.279,92
2018030	CL150-160 9.2k 460/800 60H4	5.1925.71.15	7.813,67
2018011	CL150-160 11k 460/800 60H4	5.1925.71.16	7.951,34
2018059	CL150-200 7.5k 460/800 60H4	5.1926.71.14	7.541,46
2018062	CL150-200 9.2k 460/800 60H4	5.1926.71.15	8.098,18
2018037	CL150-200 11k 460/800 60H4	5.1926.71.16	8.364,31
2018040	CL150-200 15k 460/800 60H4	5.1926.71.17	9.000,57

Item no.	Description	Art.nr. SPX	Price €
2018068	CL150-250 11k 460/800 60H4	5.1927.71.16	8.751,28
2018070	CL150-250 15k 460/800 60H4	5.1927.71.17	9.389,06
2018072	CL150-250 18.5k 460/800 60H4	5.1927.71.18	10.335,80
2018075	CL150-250 22k 460/800 60H4	5.1927.71.19	10.761,00
2019022	CL200-200 9.2k 460/800 60H4	5.1928.71.15	8.102,74
2019000	CL200-200 11k 460/800 60H4	5.1928.71.16	8.368,89
2019002	CL200-200 15k 460/800 60H4	5.1928.71.17	9.260,60
2019004	CL200-200 18.5k 460/800 60H4	5.1928.71.18	10.175,21
2019007	CL200-200 22k 460/800 60H4	5.1928.71.19	10.595,83

<b>CombiLine 460/480V 3 phase 60Hz 6-pole</b>			
Item no.	Description	Art.nr. SPX	Price €
2029002	CL80A-250 1.5k 277/480 60H6	5.1921.72.06	4.829,67
2029015	CL80A-250 2.2k 277/480 60H6	5.1921.72.07	5.143,21
2029019	CL80A-250 3k 460/800 60H6	5.1921.72.08	5.473,61
2029022	CL80A-250 4k 460/800 60H6	5.1921.72.09	5.848,30
2029027	CL80A-250 5.5k 460/800 60H6	5.1921.72.13	6.186,35
2013020	CL100-200 1.5k 277/480 60H6	5.1920.72.06	4.015,98
2013026	CL100-200 2.2k 277/480 60H6	5.1920.72.07	4.328,01
2013031	CL100-200 3k 460/800 60H6	5.1920.72.08	4.638,52
2014002	CL100A-250 1.5k 277/480 60H6	5.1922.72.06	5.403,22
2014015	CL100A-250 2.2k 277/480 60H6	5.1922.72.07	5.716,76
2014021	CL100A-250 3k 460/800 60H6	5.1922.72.08	6.027,26
2014025	CL100A-250 4k 460/800 60H6	5.1922.72.09	6.400,45
2014028	CL100A-250 5.5k 460/800 60H6	5.1922.72.13	6.738,46
2014034	CL100A-250 7.5k 460/800 60H6	5.1922.72.14	7.296,75
2015001	CL125-160 1.5k 277/480 60H6	5.1915.72.06	4.511,54
2015008	CL125-160 2.2k 277/480 60H6	5.1915.72.07	4.825,10
2017002	CL125C-200 1.5k 277/480 60H6	5.1923.72.56	4.656,85
2017007	CL125C-200 2.2k 277/480 60H6	5.1923.72.57	4.970,39
2010057	CL125C-200 3kW 460/800 60H	5.1923.72.58	5.282,41
2017012	CL125C-200 4k 460/800 60H6	5.1923.72.59	5.479,71
2016010	CL125A-250 2.2k 277/480 60H6	5.1924.72.07	6.077,71
2016016	CL125A-250 3k 460/800 60H6	5.1924.72.08	6.375,97
2016019	CL125A-250 4k 460/800 60H6	5.1924.72.09	6.813,41
2016022	CL125A-250 5.5k 460/800 60H6	5.1924.72.13	7.137,67
2016025	CL125A-250 7.5k 460/800 60H6	5.1924.72.14	7.694,41
2018009	CL150-160 1.5k 277/480 60H6	5.1925.72.06	6.158,80
2018015	CL150-160 2.2k 277/480 60H6	5.1925.72.07	6.400,45
2018018	CL150-160 3k 460/800 60H6	5.1925.72.08	6.588,59
2018021	CL150-160 4k 460/800 60H6	5.1925.72.09	6.862,36
2018034	CL150-200 1.5k 277/480 60H6	5.1926.72.06	6.339,08
2018043	CL150-200 2.2k 277/480 60H6	5.1926.72.07	6.661,99
2018047	CL150-200 3k 460/800 60H6	5.1926.72.08	6.961,77
2018050	CL150-200 4k 460/800 60H6	5.1926.72.09	7.234,01
2018055	CL150-200 5.5k 460/800 60H6	5.1926.72.13	7.555,20
2018079	CL150-250 3k 460/800 60H6	5.1927.72.08	7.435,92
2018081	CL150-250 4k 460/800 60H6	5.1927.72.09	7.708,13
2018084	CL150-250 5.5k 460/800 60H6	5.1927.72.13	8.032,42
2018087	CL150-250 7.5k 460/800 60H6	5.1927.72.14	8.602,89
2018065	CL150-250 11k 460/800 60H6	5.1927.72.16	9.133,66
2019010	CL200-200 3k 460/800 60H6	5.1928.72.08	7.116,24
2019013	CL200-200 4k 460/800 60H6	5.1928.72.09	7.550,64
2019016	CL200-200 5.5k 460/800 60H6	5.1928.72.13	7.877,94
2019019	CL200-200 7.5k 460/800 60H6	5.1928.72.14	8.501,97

<b>CombiLine 575V 3 phase 60Hz 4-pole</b>			
Item no.	Description	Art.nr. SPX	Price €
2022002	CL4/4 0.13k 333/575 60H4	5.1990.11.01	1.159,22
2022006	CL4/4 0.26k 333/575 60H2	5.1990.11.02	1.207,26
2025002	CL5/4 0.13k 333/575 60H4	5.1991.11.01	1.159,22
2025006	CL5/4 0.26k 333/575 60H2	5.1991.11.02	1.207,13
2021002	CL32-125 0.13k 333/575 60H4	5.1919.11.11	1.356,44
2024002	CL40C-125 0.13k 333/575 60H4	5.1901.11.61	1.495,89
2024005	CL40C-125 0.18k 333/575 60H4	5.1901.11.62	1.549,40
2024008	CL40C-125 0.25k 333/575 60H4	5.1901.11.51	1.617,01
2024011	CL40C-125 0.37k 333/575 60H4	5.1901.11.52	1.709,04
2023002	CL40-160 0.25k 333/575 60H4	5.1902.11.01	1.750,81
2023005	CL40-160 0.37k 333/575 60H4	5.1902.11.02	1.791,67
2023008	CL40-160 0.55k 333/575 60H4	5.1902.11.03	1.883,22
2023011	CL40-200 0.55k 333/575 60H4	5.1903.11.03	1.953,65
2023014	CL40-200 0.75k 333/575 60H4	5.1903.11.04	2.000,13
2026002	CL50-125 0.25k 333/575 60H4	5.1904.11.01	1.807,16
2026005	CL50-125 0.37k 333/575 60H4	5.1904.11.02	1.843,77
2026008	CL50-160 0.25k 333/575 60H4	5.1905.11.01	1.932,52
2026011	CL50-160 0.37k 333/575 60H4	5.1905.11.02	1.967,75
2026014	CL50-160 0.55k 333/575 60H4	5.1905.11.03	2.077,59
2026018	CL50-160 0.75k 333/575 60H4	5.1905.11.04	2.437,36
2026021	CL50-200 0.75k 333/575 60H4	5.1906.11.04	2.233,95
2026024	CL50-200 1.1k 333/575 60H4	5.1906.11.05	2.402,97
2027002	CL65-125 0.25k 333/575 60H4	5.1907.11.01	1.952,24
2027005	CL65-125 0.37k 333/575 60H4	5.1907.11.02	1.983,22
2027008	CL65-125 0.55k 333/575 60H4	5.1907.11.03	2.084,65
2027011	CL65-160 0.55k 333/575 60H4	5.1908.11.03	2.242,41
2027014	CL65-160 0.75k 333/575 60H4	5.1908.11.04	2.269,17
2027017	CL65-160 1.1k 333/575 60H4	5.1908.11.05	2.443,82
2027020	CL65-200 1.1k 333/575 60H4	5.1909.11.05	2.519,88
2027023	CL65-200 1.5k 333/575 60H4	5.1909.11.06	2.586,08
2027027	CL65-200 2.2k 575/600 60H4	5.1909.11.07	2.963,53
2028002	CL80-125 0.55k 333/575 60H4	5.1910.11.03	2.186,06
2028005	CL80-125 0.75k 333/575 60H4	5.1910.11.04	2.263,53
2028008	CL80-125 1.1k 333/575 60H4	5.1910.11.05	2.448,06
2028011	CL80-160 1.1k 333/575 60H4	5.1911.11.05	2.581,87
2028014	CL80-160 1.5k 333/575 60H4	5.1911.11.06	2.633,98
2028017	CL80-160 2.2k 575/600 60H4	5.1911.11.07	2.863,57
2028020	CL80-200 1.5k 333/575 60H4	5.1912.11.06	2.897,38
2028023	CL80-200 2.2k 575/600 60H4	5.1912.11.07	3.281,91
2028026	CL80-200 3k 575/600 60H4	5.1912.11.08	3.410,09
2029033	CL80A-250 7.5k 575/600 60H4	5.1921.11.14	6.820,15
2029036	CL80A-250 9.2k 575/600 60H4	5.1921.11.15	7.951,94
2029006	CL80A-250 11k 575/600 60H4	5.1921.11.16	8.201,26
2029009	CL80A-250 15k 575/600 60H4	5.1921.11.17	9.125,09
2029012	CL80A-250 18.5k 575/600 60H4	5.1921.11.18	10.477,23

Item no.	Description	Art.nr. SPX	Price €
2013002	CL100-150 0.75k 333/575 60H4	5.1913.11.04	2.398,75
2013005	CL100-150 1.1k 333/575 60H4	5.1913.11.05	2.628,34
2013008	CL100-150 1.5k 333/575 60H4	5.1913.11.06	2.825,54
2013011	CL100-160 1.5k 333/575 60H4	5.1914.11.06	3.124,15
2013014	CL100-160 2.2k 575/600 60H4	5.1914.11.07	3.431,20
2013017	CL100-160 3k 575/600 60H4	5.1914.11.08	3.543,88
2013029	CL100-200 2.2k 575/600 60H4	5.1920.11.07	3.824,20
2013035	CL100-200 3k 575/600 60H4	5.1920.11.08	4.025,60
2013038	CL100-200 4k 575/600 60H4	5.1920.11.09	4.448,17
2013042	CL100-200 5.5k 575/600 60H4	5.1920.11.13	5.473,59
2013045	CL100-200 7.5k 575/600 60H4	5.1920.11.14	5.910,24
2013023	CL100-200 11k 575/600 60H4	5.1920.11.16	7.343,07
2014041	CL100A-250 9.2k 575/600 60H4	5.1922.11.15	8.182,90
2014006	CL100A-250 11k 575/600 60H4	5.1922.11.16	8.455,15
2014009	CL100A-250 15k 575/600 60H4	5.1922.11.17	9.435,58
2014012	CL100A-250 18.5k 575/600 60H4	5.1922.11.18	10.789,25
2014018	CL100A-250 22k 575/600 60H4	5.1922.11.19	12.439,57
2015012	CL125-160 2.2k 575/600 60H4	5.1915.11.07	4.324,21
2015015	CL125-160 3k 575/600 60H4	5.1915.11.08	4.536,90
2015018	CL125-160 4k 575/600 60H4	5.1915.11.09	4.972,16
2015021	CL125-160 5.5k 575/600 60H4	5.1915.11.13	5.601,77
2015025	CL125-160 7.5k 575/600 60H4	5.1915.11.14	5.998,98
2015005	CL125-160 11k 575/600 60H4	5.1915.11.16	6.877,61
2017018	CL125C-200 5.5k 575/600 60H4	5.1923.11.63	5.748,26
2017021	CL125C-200 7.5k 575/600 60H4	5.1923.11.64	6.145,46
2017023	CL125C-200 9.2k 575/600 60H4	5.1923.11.65	7.282,05
2017005	CL125C-200 11k 575/600 60H4	5.1923.11.66	8.091,11
2016004	CL125A-250 15k 575/600 60H4	5.1924.11.17	10.137,61
2016007	CL125A-250 18.5k 575/600 60H4	5.1924.11.18	11.489,75
2016013	CL125A-250 22k 575/600 60H4	5.1924.11.19	12.361,58
2018001	CL150-125 2.2k 575/600 60H4	5.1929.11.07	6.589,61
2018028	CL150-160 7.5k 575/600 60H4	5.1925.11.14	8.156,85
2018031	CL150-160 9.2k 575/600 60H4	5.1925.11.15	9.282,60
2018012	CL150-160 11k 575/600 60H4	5.1925.11.16	9.420,11
2018060	CL150-200 7.5k 575/600 60H4	5.1926.11.14	8.420,26
2018063	CL150-200 9.2k 575/600 60H4	5.1926.11.15	9.567,09
2018038	CL150-200 11k 575/600 60H4	5.1926.11.16	9.833,23
2018041	CL150-200 15k 575/600 60H4	5.1926.11.17	10.643,87
2018073	CL150-250 18.5k 575/600 60H4	5.1927.11.18	12.415,08
2018076	CL150-250 22k 575/600 60H4	5.1927.11.19	13.293,01
2019005	CL200-200 18.5k 575/600 60H4	5.1928.11.18	12.254,48
2019008	CL200-200 22k 575/600 60H4	5.1928.11.19	13.127,83

<b>CombiLine 575V 3 phase 60Hz 6-pole</b>			
Item no.	Description	Art.nr. SPX	Price €
2029016	CL80A-250 2.2k 575/600 60H6	5.1921.12.07	5.708,81
2029020	CL80A-250 3k 575/600 60H6	5.1921.12.08	6.042,64
2029023	CL80A-250 4k 575/600 60H6	5.1921.12.09	6.596,20
2029028	CL80A-250 5.5k 575/600 60H6	5.1921.12.13	7.055,39
2013032	CL100-200 3k 575/600 60H6	5.1920.12.08	5.200,33
2014022	CL100A-250 3k 575/600 60H6	5.1922.12.08	6.599,01
2014026	CL100A-250 4k 575/600 60H6	5.1922.12.09	7.152,56
2014029	CL100A-250 5.5k 575/600 60H6	5.1922.12.13	7.611,75
2014035	CL100A-250 7.5k 575/600 60H6	5.1922.12.14	8.121,73
2015002	CL125-160 1.5k 333/575 60H6	5.1915.12.06	5.224,28
2015009	CL125-160 2.2k 575/600 60H6	5.1915.12.07	5.738,39
2017008	CL125C-200 2.2k 575/600 60H6	5.1923.12.57	5.884,88
2017010	CL125C-200 3k 575/600 60H6	5.1923.12.58	6.386,32
2017013	CL125C-200 4k 575/600 60H6	5.1923.12.59	6.584,93
2016020	CL125A-250 4k 575/600 60H6	5.1924.12.09	7.927,27
2016023	CL125A-250 5.5k 575/600 60H6	5.1924.12.13	8.252,65
2016026	CL125A-250 7.5k 575/600 60H6	5.1924.12.14	8.519,40
2018016	CL150-160 2.2k 575/600 60H6	5.1925.12.07	7.325,83
2018019	CL150-160 3k 575/600 60H6	5.1925.12.08	7.700,51
2018022	CL150-160 4k 575/600 60H6	5.1925.12.09	7.976,58
2018035	CL150-200 1.5k 333/575 60H6	5.1926.12.06	7.065,24
2018044	CL150-200 2.2k 575/600 60H6	5.1926.12.07	7.539,06
2018048	CL150-200 3k 575/600 60H6	5.1926.12.08	8.076,58
2018051	CL150-200 4k 575/600 60H6	5.1926.12.09	8.351,24
2018056	CL150-200 5.5k 575/600 60H6	5.1926.12.13	8.673,80
2018085	CL150-250 5.5k 575/600 60H6	5.1927.12.13	9.154,12
2018088	CL150-250 7.5k 575/600 60H6	5.1927.12.14	9.427,91
2018066	CL150-250 11k 575/600 60H6	5.1927.12.16	10.165,28
2019017	CL200-200 5.5k 575/600 60H6	5.1928.12.13	8.997,75
2019020	CL200-200 7.5k 575/600 60H6	5.1928.12.14	9.326,98

<b>CombiLine 208V 3 phase 60Hz 4-pole</b>			
Item no.	Description	Art.nr. SPX	Price €
2022000	CL4/4 0.13k 208/360 60H4	5.1990.31.01	1.580,35
2022004	CL4/4 0.26k 208/360 60H2	5.1990.31.02	1.611,88
2025000	CL5/4 0.13k 208/360 60H4	5.1991.31.01	1.580,24
2025004	CL5/4 0.26k 208/360 60H2	5.1991.31.02	1.611,88
2021000	CL32-125 0.13k 208/360 60H4	5.1919.31.11	1.782,01
2024000	CL40C-125 0.13k 208/360 60H4	5.1901.31.61	1.923,79
2024003	CL40C-125 0.18k 208/360 60H4	5.1901.31.62	1.961,18
2024006	CL40C-125 0.25k 208/360 60H4	5.1901.31.51	2.030,91
2024009	CL40C-125 0.37k 208/360 60H4	5.1901.31.52	2.073,80
2023000	CL40-160 0.25k 208/360 60H4	5.1902.31.01	2.167,96
2023003	CL40-160 0.37k 208/360 60H4	5.1902.31.02	2.210,48
2023006	CL40-160 0.55k 208/360 60H4	5.1902.31.03	2.248,32
2023009	CL40-200 0.55k 208/360 60H4	5.1903.31.03	2.320,78
2023012	CL40-200 0.75k 208/360 60H4	5.1903.31.04	2.397,13
2023016	CL40-200 1.1k 208/360 60H4	5.1903.31.05	2.658,81
2026000	CL50-125 0.25k 208/360 60H2	5.1904.31.01	2.224,68
2026003	CL50-125 0.37k 208/360 60H4	5.1904.31.02	2.262,49
2026006	CL50-160 0.25k 208/360 60H4	5.1905.31.01	2.329,03
2026009	CL50-160 0.37k 208/360 60H4	5.1905.31.02	2.390,10
2026012	CL50-160 0.55k 208/360 60H4	5.1905.31.03	2.446,80
2026016	CL50-160 0.75k 208/360 60H4	5.1905.31.04	2.510,48
2026019	CL50-200 0.75k 208/360 60H4	5.1906.31.04	2.636,55
2026022	CL50-200 1.1k 208/360 60H4	5.1906.31.05	2.898,25
2026026	CL50-200 1.5k 208/360 60H4	5.1906.31.06	2.966,92
2027000	CL65-125 0.25k 208/360 60H4	5.1907.31.01	2.374,34
2027003	CL65-125 0.37k 208/360 60H4	5.1907.31.02	2.405,85
2027006	CL65-125 0.55k 208/360 60H4	5.1907.31.03	2.454,70
2027009	CL65-160 0.55k 208/360 60H4	5.1908.31.03	2.615,38
2027012	CL65-160 0.75k 208/360 60H4	5.1908.31.04	2.671,25
2027015	CL65-160 1.1k 208/360 60H4	5.1908.31.05	2.940,79
2027018	CL65-200 1.1k 208/360 60H4	5.1909.31.05	3.018,00
2027021	CL65-200 1.5k 208/360 60H4	5.1909.31.06	3.087,30
2027025	CL65-200 2.2k 208/360 60H4	5.1909.31.07	3.564,21
2028000	CL80-125 0.55k 208/360 60H4	5.1910.31.03	2.558,65
2028003	CL80-125 0.75k 208/360 60H4	5.1910.31.04	2.666,52
2028006	CL80-125 1.1k 208/360 60H4	5.1910.31.05	2.945,52
2028009	CL80-160 1.1k 208/360 60H4	5.1911.31.05	3.082,57
2028012	CL80-160 1.5k 208/360 60H4	5.1911.31.06	3.136,14
2028015	CL80-160 2.2k 208/360 60H4	5.1911.31.07	3.387,35
2028018	CL80-200 1.5k 208/360 60H4	5.1912.31.06	3.403,94
2028021	CL80-200 2.2k 208/360 60H4	5.1912.31.07	3.814,29
2028024	CL80-200 3k 208/360 60H4	5.1912.31.08	3.945,08

Item no.	Description	Art.nr. SPX	Price €
2029025	CL80A-250 4k 208/360 60H4	5.1921.31.09	6.305,32
2029030	CL80A-250 5.5k 208/360 60H4	5.1921.31.13	7.133,66
2029031	CL80A-250 7.5k 208/360 60H4	5.1921.31.14	7.510,17
2029034	CL80A-250 9.2k 208/360 60H4	5.1921.31.15	8.987,64
2029004	CL80A-250 11k 208/360 60H4	5.1921.31.16	9.244,44
2029007	CL80A-250 15k 208/360 60H4	5.1921.31.17	10.268,48
2029010	CL80A-250 18.5k 208/360 60H4	5.1921.31.18	11.842,39
2013000	CL100-150 0.75k 208/360 60H4	5.1913.31.04	2.805,14
2013003	CL100-150 1.1k 208/360 60H4	5.1913.31.05	3.129,82
2013006	CL100-150 1.5k 208/360 60H4	5.1913.31.06	3.331,48
2013009	CL100-160 1.5k 208/360 60H4	5.1914.31.06	3.637,10
2013012	CL100-160 2.2k 208/360 60H4	5.1914.31.07	3.968,69
2013015	CL100-160 3k 208/360 60H4	5.1914.31.08	4.083,70
2013027	CL100-200 2.2k 208/360 60H4	5.1920.31.07	4.368,82
2013033	CL100-200 3k 208/360 60H4	5.1920.31.08	4.575,25
2013036	CL100-200 4k 208/360 60H4	5.1920.31.09	4.904,80
2013040	CL100-200 5.5k 208/360 60H4	5.1920.31.13	6.133,32
2013043	CL100-200 7.5k 208/360 60H4	5.1920.31.14	6.579,12
2013021	CL100-200 11k 208/360 60H4	5.1920.31.16	8.360,50
2014031	CL100A-250 5.5k 208/360 60H4	5.1922.31.13	7.406,18
2014036	CL100A-250 7.5k 208/360 60H4	5.1922.31.14	7.749,62
2014039	CL100A-250 9.2k 208/360 60H4	5.1922.31.15	9.225,52
2014004	CL100A-250 11k 208/360 60H4	5.1922.31.16	9.505,96
2014007	CL100A-250 15k 208/360 60H4	5.1922.31.17	10.588,27
2014010	CL100A-250 18.5k 208/360 60H4	5.1922.31.18	12.163,75
2014016	CL100A-250 22k 208/360 60H4	5.1922.31.19	14.051,74
2015010	CL125-160 2.2k 208/360 60H4	5.1915.31.07	4.882,38
2015013	CL125-160 3k 208/360 60H4	5.1915.31.08	5.099,81
2015016	CL125-160 4k 208/360 60H4	5.1915.31.09	5.440,43
2015019	CL125-160 5.5k 208/360 60H4	5.1915.31.13	6.264,06
2015023	CL125-160 7.5k 208/360 60H4	5.1915.31.14	6.670,51
2015003	CL125-160 11k 208/360 60H4	5.1915.31.16	7.881,10
2017014	CL125C-200 4k 208/360 60H4	5.1923.31.69	5.590,11
2017016	CL125C-200 5.5k 208/360 60H4	5.1923.31.63	6.415,28
2017019	CL125C-200 7.5k 208/360 60H4	5.1923.31.64	6.820,15
2017022	CL125C-200 9.2k 208/360 60H4	5.1923.31.65	8.297,64
2017003	CL125C-200 11k 208/360 60H4	5.1923.31.66	9.131,00
2016028	CL125A-250 7.5k 208/360 60H4	5.1924.31.14	8.379,75
2016029	CL125A-250 9.2k 208/360 60H4	5.1924.31.15	9.885,62
2016002	CL125A-250 15k 208/360 60H4	5.1924.31.17	11.311,39
2016005	CL125A-250 18.5k 208/360 60H4	5.1924.31.18	12.885,30
2016011	CL125A-250 22k 208/360 60H4	5.1924.31.19	13.971,42
2018000	CL150-125 2.2k 208/360 60H4	5.1929.31.07	6.790,14
2018003	CL150-125 3k 208/360 60H4	5.1929.31.08	7.009,16
2018005	CL150-125 4k 208/360 60H4	5.1929.31.09	7.412,83
2018023	CL150-160 4k 208/360 60H4	5.1925.31.09	7.395,46
2018024	CL150-160 5.5k 208/360 60H4	5.1925.31.13	8.425,46
2018026	CL150-160 7.5k 208/360 60H4	5.1925.31.14	8.877,60
2018029	CL150-160 9.2k 208/360 60H4	5.1925.31.15	10.358,22
2018010	CL150-160 11k 208/360 60H4	5.1925.31.16	10.500,02

Item no.	Description	Art.nr. SPX	Price €
2018053	CL150-200 4k 208/360 60H4	5.1926.31.09	7.660,13
2018057	CL150-200 5.5k 208/360 60H4	5.1926.31.13	8.690,13
2018058	CL150-200 7.5k 208/360 60H4	5.1926.31.14	9.146,99
2018061	CL150-200 9.2k 208/360 60H4	5.1926.31.15	10.651,23
2018036	CL150-200 11k 208/360 60H4	5.1926.31.16	10.925,36
2018039	CL150-200 15k 208/360 60H4	5.1926.31.17	11.832,84
2018069	CL150-250 15k 208/360 60H4	5.1927.31.17	12.232,96
2018071	CL150-250 18.5k 208/360 60H4	5.1927.31.18	13.838,37
2018074	CL150-250 22k 208/360 60H4	5.1927.31.19	14.930,81
2019001	CL200-200 15k 208/360 60H4	5.1928.31.17	12.100,63
2019003	CL200-200 18.5k 208/360 60H4	5.1928.31.18	13.672,93
2019006	CL200-200 22k 208/360 60H4	5.1928.31.19	14.760,68

<b>CombiLine 208V 3 phase 60Hz 6-pole</b>			
Item no.	Description	Art.nr. SPX	Price €
2029001	CL80A-250 1.5k 208/360 60H6	5.1921.32.06	6.353,84
2029014	CL80A-250 2.2k 208/360 60H6	5.1921.32.07	6.885,27
2029018	CL80A-250 3k 208/360 60H6	5.1921.32.08	7.540,70
2029021	CL80A-250 4k 208/360 60H6	5.1921.32.09	7.926,62
2029026	CL80A-250 5.5k 208/360 60H6	5.1921.32.13	8.274,81
2013019	CL100-200 1.5k 208/360 60H6	5.1920.32.06	5.515,76
2013025	CL100-200 2.2k 208/360 60H6	5.1920.32.07	6.045,58
2013030	CL100-200 3k 208/360 60H6	5.1920.32.08	6.680,55
2014001	CL100A-250 1.5k 208/360 60H6	5.1922.32.06	6.944,59
2014014	CL100A-250 2.2k 208/360 60H6	5.1922.32.07	7.476,04
2014020	CL100A-250 3k 208/360 60H6	5.1922.32.08	8.110,95
2014024	CL100A-250 4k 208/360 60H6	5.1922.32.09	8.495,36
2014027	CL100A-250 5.5k 208/360 60H6	5.1922.32.13	8.843,49
2014033	CL100A-250 7.5k 208/360 60H6	5.1922.32.14	10.679,04
2015000	CL125-160 1.5k 208/360 60H6	5.1915.32.06	6.026,15
2015007	CL125-160 2.2k 208/360 60H6	5.1915.32.07	6.557,62
2017001	CL125C-200 1.5k 208/360 60H6	5.1923.32.56	6.175,83
2017006	CL125C-200 2.2K 208/360 60H6	5.1923.32.57	6.707,24
2017009	CL125C-200 3k 208/360 60H6	5.1923.32.58	7.343,74
2017011	CL125C-200 4k 208/360 60H6	5.1923.32.59	7.546,97
2016009	CL125A-250 2.2k 208/360 60H6	5.1924.32.07	7.847,79
2016015	CL125A-250 3k 208/360 60H6	5.1924.32.08	8.470,16
2016018	CL125A-250 4k 208/360 60H6	5.1924.32.09	8.920,70
2016021	CL125A-250 5.5k 208/360 60H6	5.1924.32.13	9.254,67
2016024	CL125A-250 7.5k 208/360 60H6	5.1924.32.14	11.088,62
2018008	CL150-160 1.5k 208/360 60H6	5.1925.32.06	7.722,86
2018014	CL150-160 2.2k 208/360 60H6	5.1925.32.07	8.180,24
2018017	CL150-160 3k 208/360 60H6	5.1925.32.08	8.689,12
2018020	CL150-160 4k 208/360 60H6	5.1925.32.09	8.971,11
2018033	CL150-200 1.5k 208/360 60H6	5.1926.32.06	7.908,54
2018042	CL150-200 2.2k 208/360 60H6	5.1926.32.07	8.449,59
2018046	CL150-200 3k 208/360 60H6	5.1926.32.08	9.073,53
2018049	CL150-200 4k 208/360 60H6	5.1926.32.09	9.353,89
2018054	CL150-200 5.5k 208/360 60H6	5.1926.32.13	9.684,75
2018078	CL150-250 3k 208/360 60H6	5.1927.32.08	9.561,88
2018080	CL150-250 4k 208/360 60H6	5.1927.32.09	9.842,27
2018083	CL150-250 5.5k 208/360 60H6	5.1927.32.13	10.176,27
2018086	CL150-250 7.5k 208/360 60H6	5.1927.32.14	12.024,38
2018064	CL150-250 11k 208/360 60H6	5.1927.32.16	12.571,08
2019009	CL200-200 3k 208/360 60H6	5.1928.32.08	9.232,62
2019012	CL200-200 4k 208/360 60H6	5.1928.32.09	9.680,04
2019015	CL200-200 5.5k 208/360 60H6	5.1928.32.13	10.017,15
2019018	CL200-200 7.5k 208/360 60H6	5.1928.32.14	11.920,42

<b>CombiBlockHorti 230/400 3 phase 50Hz 4-pole</b>			
Item no.	Description	Art.nr. SPX	Price €
2057007	CBH80C-200 2.2k 400/690 50H4	5.6821.01.57	3.271,44
2057009	CBH80C-200 3k 400/690 50H4	5.6821.01.58	3.438,90
2057012	CBH80C-200 4k 400/690 50H4	5.6821.01.59	3.868,16
2057016	CBH80C-200 5.5k 400/690 50H4	5.6821.01.63	4.028,04
2056009	CBH80-250 3k 400/690 50H4	5.6822.01.08	3.702,25
2056014	CBH80-250 4k 400/690 50H4	5.6822.01.09	4.133,06
2056016	CBH80-250 5.5k 400/690 50H4	5.6822.01.13	4.292,90
2056020	CBH80-250 7.5k 400/690 50H4	5.6822.01.14	4.892,67
2050007	CBH100-160 2.2k 400/690 50H4	5.6826.01.07	3.434,34
2050009	CBH100-160 3k 400/690 50H4	5.6826.01.08	3.601,76
2050013	CBH100-160 4k 400/690 50H4	5.6826.01.09	4.032,57
2051012	CBH100C-200 4k 400/690 50H4	5.6827.01.59	4.260,92
2051014	CBH100C-200 5.5k 400/690 50H4	5.6827.01.63	4.586,71
2051017	CBH100C-200 7.5k 400/690 50H4	5.6827.01.64	4.967,29
2051041	CBH100C-250 4k 400/690 50H4	5.6828.01.59	4.534,95
2040499	CBH100C-250 5.5kW 400/690 50H	5.6828.01.63	4.860,72
2040500	CBH100C-250 7.5kW 400/690 50H	5.6828.01.64	5.153,00
2052026	CBH125-250 7.5k 400/690 50H4	5.6832.01.14	5.679,71
2052000	CBH125-250 11k 400/690 50H4	5.6832.01.16	6.373,90
2052001	CBH125-250 15k 400/690 50H4	5.6832.01.17	7.100,02
2053000	CBH150-125 2.2k 400/690 50H4	5.6835.01.07	4.618,67
2040501	CBH150-125 3kW 400/690 50H	5.6835.01.08	4.653,70
2053003	CBH150-125 4k 400/690 50H4	5.6835.01.09	5.105,82
2053016	CBH150-160 4k 400/690 50H4	5.6836.01.09	5.381,35
2053018	CBH150-160 5.5k 400/690 50H4	5.6836.01.13	5.716,26
2053020	CBH150-160 7.5k 400/690 50H4	5.6836.01.14	6.086,19
2053039	CBH150-200 4k 400/690 50H4	5.6837.01.09	5.615,79
2053041	CBH150-200 5.5k 400/690 50H4	5.6837.01.13	5.929,38
2053044	CBH150-200 7.5k 400/690 50H4	5.6837.01.14	6.303,87
2053048	CBH150-250 15k 400/690 50H4	5.6838.01.17	7.631,30
2040502	CBH200-200 11kW 400/690 50H	5.6842.01.16	6.999,54
2054001	CBH200-200 15k 400/690 50H4	5.6842.01.17	7.750,05
2040503	CBH250-200 11kW 400/690 50H	5.6843.01.16	7.617,62
2040504	CBH250-200 15kW 400/690 50H	5.6843.01.17	7.996,65

<b>CombiBlockHorti 230/400 3 phase 50Hz 6-pole</b>			
Item no.	Description	Art.nr. SPX	Price €
2057000	CBH80C-200 1.5k 230/400 50H6	5.6821.02.56	3.438,90
2056005	CBH80-250 3k 400/690 50H6	5.6822.02.08	3.877,31
2050000	CBH100-160 1.5k 230/400 50H6	5.6826.02.06	3.790,54
2051000	CBH100C-200 1.5k 230/400 50H6	5.6827.02.56	4.017,36
2051005	CBH100C-200 2.2k 400/690 50H6	5.6827.02.57	4.206,14
2051021	CBH100C-250 1.5k 230/400 50H6	5.6828.02.56	4.437,52
2051030	CBH100C-250 2.2k 400/690 50H6	5.6828.02.57	4.626,32
2051034	CBH100C-250 3k 400/690 50H6	5.6828.02.58	4.882,05
2052008	CBH125-250 2.2k 400/690 50H6	5.6832.02.07	5.046,45
2052013	CBH125-250 3k 400/690 50H6	5.6832.02.08	5.302,19
2052016	CBH125-250 4k 400/690 50H6	5.6832.02.09	5.670,58
2053007	CBH150-160 1.5k 230/400 50H6	5.6836.02.06	5.116,48
2053009	CBH150-160 2.2k 400/690 50H6	5.6836.02.07	5.320,45
2053028	CBH150-200 2.2k 400/690 50H6	5.6837.02.07	5.542,70
2053032	CBH150-200 3k 400/690 50H6	5.6837.02.08	5.799,96
2053052	CBH150-250 5.5k 400/690 50H6	5.6838.02.13	6.510,91
2053055	CBH150-250 7.5k 400/690 50H6	5.6838.02.14	6.982,82
2054011	CBH200-200 3k 400/690 50H6	5.6842.02.08	5.927,94
2054014	CBH200-200 4k 400/690 50H6	5.6842.02.09	6.296,24
2054017	CBH200-200 5.5k 400/690 50H6	5.6842.02.13	6.577,90
2040508	CBH250-200 5.5kW 400/690 50H	5.6843.02.13	7.189,84
2040509	CBH250-200 7.5kW 400/690 50H	5.6843.02.14	7.750,05

<b>CombiBlockHorti 460/480V 3 phase 60Hz 4-pole</b>			
Item no.	Description	Art.nr. SPX	Price €
2057011	CBH80C-200 3k 460/800 60H4	5.6821.71.58	3.835,78
2057014	CBH80C-200 4k 460/800 60H4	5.6821.71.59	4.001,70
2057018	CBH80C-200 5.5k 460/800 60H4	5.6821.71.63	4.161,56
2057021	CBH80C-200 7.5k 460/800 60H4	5.6821.71.64	4.461,43
2056018	CBH80-250 5.5k 460/800 60H4	5.6822.71.13	4.426,43
2056022	CBH80-250 7.5k 460/800 60H4	5.6822.71.14	5.026,19
2056001	CBH80-250 11k 460/800 60H4	5.6822.71.16	5.944,12
2040510	CBH80-250 15kW 460/800 60H	5.6822.71.17	6.617,00
2050011	CBH100-160 3k 460/800 60H4	5.6826.71.08	3.735,28
2050015	CBH100-160 4k 460/800 60H4	5.6826.71.09	4.166,12
2050018	CBH100-160 5.5k 460/800 60H4	5.6826.71.13	4.491,89
2050021	CBH100-160 7.5k 460/800 60H4	5.6826.71.14	4.872,44
2051016	CBH100C-200 5.5k 460/800 60H4	5.6827.71.63	4.718,90
2051019	CBH100C-200 7.5k 460/800 60H4	5.6827.71.64	5.100,82
2040511	CBH100C-200 11kW 460/800 60H	5.6827.71.66	6.040,04
2051043	CBH100C-250 5.5k 460/800 60H4	5.6828.71.63	4.994,24
2051046	CBH100C-250 7.5k 460/800 60H4	5.6828.71.64	5.286,53
2051025	CBH100C-250 11k 460/800 60H4	5.6828.71.66	6.314,05
2051028	CBH100C-250 15k 460/800 60H4	5.6828.71.67	6.986,92
2052003	CBH125-250 15k 460/800 60H4	5.6832.71.17	7.233,53
2052006	CBH125-250 18.5k 460/800 60H4	5.6832.71.18	8.012,95
2052011	CBH125-250 22k 460/800 60H4	5.6832.71.19	8.366,13
2053005	CBH150-125 4k 460/800 60H4	5.6835.71.09	5.239,32
2053022	CBH150-160 7.5k 460/800 60H4	5.6836.71.14	6.219,69
2053043	CBH150-200 5.5k 460/800 60H4	5.6837.71.13	6.062,90
2053046	CBH150-200 7.5k 460/800 60H4	5.6837.71.14	6.437,38
2053025	CBH150-200 11k 460/800 60H4	5.6837.71.16	7.133,06
2053027	CBH150-200 15k 460/800 60H4	5.6837.71.17	7.882,82
2053051	CBH150-250 22k 480/800 60H4	5.6838.71.19	8.895,90
2054003	CBH200-200 15k 460/800 60H4	5.6842.71.17	7.883,57
2054006	CBH200-200 18.5k 460/800 60H4	5.6842.71.18	8.662,98
2054009	CBH200-200 22k 460/800 60H4	5.6842.71.19	9.014,63
2055007	CBH250-200 22k 460/800 60H4	5.6843.71.19	9.580,93
2040505	CBH250-200 18.5kW 460/800 60H	5.6843.71.18	9.230,79
2040512	CBH250-200 22kW 575/600 60H	5.6843.71.19	12.101,06

<b>CombiBlockHorti 460/480V 3 phase 60Hz 6-pole</b>			
Item no.	Description	Art.nr. SPX	Price €
2057002	CBH80C-200 1.5k 277/480 60H6	5.6821.72.56	3.572,41
2057005	CBH80C-200 2.2k 277/480 60H6	5.6821.72.57	3.758,14
2056007	CBH80-250 3k 460/800 60H6	5.6822.72.08	4.010,85
2056012	CBH80-250 4k 460/800 60H6	5.6822.72.09	4.380,74
2050002	CBH100-160 1.5k 277/480 60H6	5.6826.72.06	3.924,05
2050005	CBH100-160 2.2k 277/480 60H6	5.6826.72.07	4.111,28
2051002	CBH100C-200 1.5k 277/480 60H6	5.6827.72.56	4.150,87
2051007	CBH100C-200 2.2k 277/480 60H6	5.6827.72.57	4.339,67
2051010	CBH100C-200 3k 460/800 60H6	5.6827.72.58	4.595,39
2051023	CBH100C-250 1.5k 277/480 60H6	5.6828.72.56	4.571,03
2051032	CBH100C-250 2.2k 277/480 60H6	5.6828.72.57	4.759,81
2051036	CBH100C-250 3k 460/800 60H6	5.6828.72.58	5.015,55
2051039	CBH100C-250 4k 460/800 60H6	5.6828.72.59	5.385,47
2052015	CBH125-250 3k 460/800 60H6	5.6832.72.08	5.435,72
2052018	CBH125-250 4k 460/800 60H6	5.6832.72.09	5.804,10
2052021	CBH125-250 5.5k 460/800 60H6	5.6832.72.13	6.082,66
2052024	CBH125-250 7.5k 460/800 60H6	5.6832.72.14	6.557,66
2053011	CBH150-160 2.2k 277/480 60H6	5.6836.72.07	5.453,97
2053014	CBH150-160 3k 460/800 60H6	5.6836.72.08	5.709,73
2053030	CBH150-200 2.2k 277/480 60H6	5.6837.72.07	5.676,21
2053034	CBH150-200 3k 460/800 60H6	5.6837.72.08	5.933,47
2053037	CBH150-200 4k 460/800 60H6	5.6837.72.09	6.303,43
2053054	CBH150-250 5.5k 460/800 60H6	5.6838.72.13	6.644,43
2053057	CBH150-250 7.5k 460/800 60H6	5.6838.72.14	7.116,33
2054013	CBH200-200 3k 460/800 60H6	5.6842.72.08	On request
2054016	CBH200-200 4k 460/800 60H6	5.6842.72.09	On request
2054019	CBH200-200 5.5k 460/800 60H6	5.6842.72.13	6.711,41
2054022	CBH200-200 7.5k 460/800 60H6	5.6842.72.14	7.239,62
2055009	CBH250-200 5.5k 460/800 60H6	5.6843.72.13	7.323,36
2055012	CBH250-200 7.5k 460/800 60H6	5.6843.72.14	7.883,57
2055001	CBH250-200 11k 460/800 60H6	5.6843.72.16	8.235,31

<b>CombiBlockHorti 575V 3 phase 60Hz 4-pole</b>			
Item no.	Description	Art.nr. SPX	Price €
2057015	CBH80-200 4k 575/600 60H4	5.6821.11.59	4.734,31
2057019	CBH80-200 5.5k 575/600 60H4	5.6821.11.63	5.013,30
2057022	CBH80-200 7.5k 575/600 60H4	5.6821.11.64	5.314,70
2056019	CBH80-250 5.5k 575/600 60H4	5.6822.11.13	5.279,66
2056023	CBH80-250 7.5k 575/600 60H4	5.6822.11.14	5.882,49
2056002	CBH80-250 11k 575/600 60H4	5.6822.11.16	7.406,18
2056004	CBH80-250 15k 575/600 60H4	5.6822.11.17	8.252,58
2050012	CBH100-160 3k 575/600 60H4	5.6826.11.08	4.289,91
2050016	CBH100-160 4k 575/600 60H4	5.6826.11.09	4.899,74
2050019	CBH100-160 5.5k 575/600 60H4	5.6826.11.13	5.345,55
2050022	CBH100-160 7.5k 575/600 60H4	5.6826.11.14	5.728,27
2051020	CBH100-200 7.5k 575/600 60H4	5.6827.11.64	5.959,59
2051004	CBH100-200 11k 575/600 60H4	5.6827.11.66	7.502,07
2051044	CBH100C-250 5.5k 575/600 60H4	5.6828.11.63	5.850,11
2051047	CBH100C-250 7.5k 575/600 60H4	5.6828.11.64	6.144,66
2051026	CBH100C-250 11k 575/600 60H4	5.6828.11.66	7.776,06
2051029	CBH100C-250 15k 575/600 60H4	5.6828.11.67	8.622,50
2052004	CBH125-250 15k 575/600 60H4	5.6832.11.17	8.869,11
2052007	CBH125-250 18.5k 575/600 60H4	5.6832.11.18	10.082,45
2052012	CBH125-250 22k 575/600 60H4	5.6832.11.19	10.886,25
2053006	CBH150-125 4k 575/600 60H4	5.6835.11.09	5.979,22
2053023	CBH150-160 7.5k 575/600 60H4	5.6836.11.14	7.085,35
2053047	CBH150-200 7.5k 575/600 60H4	5.6837.11.14	7.304,04
2053026	CBH150-200 11k 575/600 60H4	5.6837.11.16	8.595,06
2054004	CBH200-200 15k 575/600 60H4	5.6842.11.17	9.519,15
2054007	CBH200-200 18.5k 575/600 60H4	5.6842.11.18	11.084,13
2054010	CBH200-200 22k 575/600 60H4	5.6842.11.19	11.534,75
2055005	CBH250-200 18.5k 575/600 60H4	5.6843.11.18	11.300,30

<b>CombiBlockHorti 575V 3 phase 60Hz 6-pole</b>			
Item no.	Description	Art.nr. SPX	Price €
2057003	CBH80-200 1.5k 333/575 60H6	5.6821.12.56	4.275,88
2057006	CBH80-200 2.2k 575/600 60H6	5.6821.12.57	4.661,42
2056008	CBH80-250 3k 575/600 60H6	5.6822.12.08	5.099,26
2056013	CBH80-250 4k 575/600 60H6	5.6822.12.09	5.473,13
2050003	CBH100-160 1.5k 333/575 60H6	5.6826.12.06	4.630,57
2050006	CBH100-160 2.2k 575/600 60H6	5.6826.12.07	5.016,09
2051008	CBH100-200 2.2k 575/600 60H6	5.6827.12.57	5.247,41
2051011	CBH100-200 3k 575/600 60H6	5.6827.12.58	5.689,02
2051033	CBH100-250 2.2k 575/600 60H6	5.6828.12.57	5.669,40
2051037	CBH100-250 3k 575/600 60H6	5.6828.12.58	6.111,00
2051040	CBH100-250 4k 575/600 60H6	5.6828.12.59	6.483,91
2052019	CBH125-250 4k 575/600 60H6	5.6832.12.09	6.905,90
2052022	CBH125-250 5.5k 575/600 60H6	5.6832.12.13	7.186,28
2052025	CBH125-250 7.5k 575/600 60H6	5.6832.12.14	8.607,12
2053012	CBH150-160 2.2k 575/600 60H6	5.6836.12.07	6.368,96
2053015	CBH150-160 3k 575/600 60H6	5.6836.12.08	6.810,56
2053031	CBH150-200 2.2k 575/600 60H6	5.6837.12.07	6.591,87
2053035	CBH150-200 3k 575/600 60H6	5.6837.12.08	7.036,27
2053038	CBH150-200 4k 575/600 60H6	5.6837.12.09	7.409,19
2053058	CBH150-250 7.5k 575/600 60H6	5.6838.12.14	9.165,81
2054020	CBH200-200 5.5k 575/600 60H6	5.6842.12.13	7.819,95
2054023	CBH200-200 7.5k 575/600 60H6	5.6842.12.14	9.289,10
2055010	CBH250-200 5.5k 575/600 60H6	5.6843.12.13	8.435,40
2055013	CBH250-200 7.5k 575/600 60H6	5.6843.12.14	9.933,04
2055002	CBH250-200 11k 575/600 60H6	5.6843.12.16	10.284,81

<b>CombiBlockHorti 208V 3 phase 60Hz 4-pole</b>			
Item no.	Description	Art.nr. SPX	Price €
2057008	CBH80C-200 2.2k 208/360 60H4	5.6821.31.57	4.363,99
2057010	CBH80C-200 3k 208/360 60H4	5.6821.31.58	4.536,45
2057013	CBH80C-200 4k 208/360 60H4	5.6821.31.59	5.046,32
2057017	CBH80C-200 5.5k 208/360 60H4	5.6821.31.63	5.473,32
2057020	CBH80C-200 7.5k 208/360 60H4	5.6821.31.64	5.782,21
2056010	CBH80-250 3k 208/360 60H4	5.6822.31.08	4.807,69
2056015	CBH80-250 4k 208/360 60H4	5.6822.31.09	5.319,14
2056017	CBH80-250 5.5k 208/360 60H4	5.6822.31.13	5.746,12
2056021	CBH80-250 7.5k 208/360 60H4	5.6822.31.14	6.363,91
2056000	CBH80-250 11k 208/360 60H4	5.6822.31.16	8.121,87
2056003	CBH80-250 15k 208/360 60H4	5.6822.31.17	9.034,89
2050008	CBH100-160 2.2k 208/360 60H4	5.6826.31.07	4.531,76
2050010	CBH100-160 3k 208/360 60H4	5.6826.31.08	4.704,21
2050014	CBH100-160 4k 208/360 60H4	5.6826.31.09	5.215,67
2050017	CBH100-160 5.5k 208/360 60H4	5.6826.31.13	5.813,56
2050020	CBH100-160 7.5k 208/360 60H4	5.6826.31.14	6.205,53
2051013	CBH100C-200 4K 208/360 60H4	5.6827.31.59	5.450,85
2051015	CBH100C-200 5.5k 208/360 60H4	5.6827.31.63	6.048,76
2051018	CBH100C-200 7.5k 208/360 60H4	5.6827.31.64	6.440,75
2051003	CBH100C-200 11k 208/360 60H4	5.6827.31.66	8.220,60
2051042	CBH100C-250 5.5k 208/360 60H4	5.6828.31.63	6.331,00
2051045	CBH100C-250 7.5k 208/360 60H4	5.6828.31.64	6.632,04
2051024	CBH100C-250 11k 208/360 60H4	5.6828.31.66	8.502,84
2051027	CBH100C-250 15k 208/360 60H4	5.6828.31.67	9.415,92
2052002	CBH125-250 15k 208/360 60H4	5.6832.31.17	9.669,95
2052005	CBH125-250 18.5k 208/360 60H4	5.6832.31.18	11.022,84
2052010	CBH125-250 22k 208/360 60H4	5.6832.31.19	11.957,85
2053001	CBH150-125 2.2k 208/360 60H4	5.6835.31.07	5.751,63
2053002	CBH150-125 3k 208/360 60H4	5.6835.31.08	5.787,70
2053004	CBH150-125 4k 208/360 60H4	5.6835.31.09	6.321,08
2053017	CBH150-160 4k 208/360 60H4	5.6836.31.09	6.604,89
2053019	CBH150-160 5.5k 208/360 60H4	5.6836.31.13	7.212,20
2053021	CBH150-160 7.5k 208/360 60H4	5.6836.31.14	7.593,21
2053040	CBH150-200 4k 208/360 60H4	5.6837.31.09	6.846,37
2053042	CBH150-200 5.5k 208/360 60H4	5.6837.31.13	7.431,70
2053045	CBH150-200 7.5k 208/360 60H4	5.6837.31.14	7.817,42
2053024	CBH150-200 11k 208/360 60H4	5.6837.31.16	9.346,42
2053049	CBH150-250 15k 208/360 60H4	5.6838.31.17	10.217,16
2053050	CBH150-250 22k 208/360 60H4	5.6838.31.19	12.503,50
2054002	CBH200-200 15k 208/360 60H4	5.6842.31.17	10.339,47
2054005	CBH200-200 18.5k 208/360 60H4	5.6842.31.18	11.692,35
2054008	CBH200-200 22k 208/360 60H4	5.6842.31.19	12.625,80
2055003	CBH250-200 15k 208/360 60H4	5.6843.31.17	10.593,47
2055004	CBH250-200 18.5k 208/360 60H4	5.6843.31.18	12.277,20
2055006	CBH250-200 22k 208/360 60H4	5.6843.31.19	13.209,08

<b>CombiBlockHorti 208V 3 phase 60Hz 6-pole</b>			
Item no.	Description	Art.nr. SPX	Price €
2057001	CBH80C-200 1.5k 208/360 60H6	5.6821.32.56	4.866,51
2057004	CBH80C-200 2.2k 208/360 60H6	5.6821.32.57	5.239,74
2056006	CBH80-250 3k 208/360 60H6	5.6822.32.08	5.775,10
2056011	CBH80-250 4k 208/360 60H6	5.6822.32.09	6.156,08
2050001	CBH100-160 1.5k 208/360 60H6	5.6826.32.06	5.228,69
2050004	CBH100-160 2.2k 208/360 60H6	5.6826.32.07	5.603,51
2051001	CBH100C-200 1.5k 208/360 60H6	5.6827.32.56	5.462,32
2051006	CBH100C-200 2.2k 208/360 60H6	5.6827.32.57	5.838,72
2051009	CBH100C-200 3k 208/360 60H6	5.6827.32.58	6.377,16
2051022	CBH100C-250 1.5k 208/360 60H6	5.6828.32.56	5.895,10
2051031	CBH100C-250 2.2k 208/360 60H6	5.6828.32.57	6.271,46
2051035	CBH100C-250 3k 208/360 60H6	5.6828.32.58	6.809,94
2051038	CBH100C-250 4k 208/360 60H6	5.6828.32.59	7.190,95
2052009	CBH125-250 2.2k 208/360 60H6	5.6832.32.07	6.704,22
2052014	CBH125-250 3k 208/360 60H6	5.6832.32.08	7.242,72
2052017	CBH125-250 4k 208/360 60H6	5.6832.32.09	7.622,14
2052020	CBH125-250 5.5k 208/360 60H6	5.6832.32.13	7.909,05
2052023	CBH125-250 7.5k 208/360 60H6	5.6832.32.14	9.498,49
2053008	CBH150-160 1.5k 208/360 60H6	5.6836.32.06	6.594,41
2053010	CBH150-160 2.2k 208/360 60H6	5.6836.32.07	6.986,46
2053013	CBH150-160 3k 208/360 60H6	5.6836.32.08	7.524,92
2053029	CBH150-200 2.2k 208/360 60H6	5.6837.32.07	7.215,38
2053033	CBH150-200 3k 208/360 60H6	5.6837.32.08	7.755,39
2053036	CBH150-200 4k 208/360 60H6	5.6837.32.09	8.136,45
2053053	CBH150-250 5.5k 208/360 60H6	5.6838.32.13	8.487,68
2053056	CBH150-250 7.5k 208/360 60H6	5.6838.32.14	10.073,92
2054012	CBH200-200 3k 208/360 60H6	5.6842.32.08	7.887,23
2054015	CBH200-200 4k 208/360 60H6	5.6842.32.09	8.266,56
2054018	CBH200-200 5.5k 208/360 60H6	5.6842.32.13	8.556,67
2054021	CBH200-200 7.5k 208/360 60H6	5.6842.32.14	10.200,92
2055008	CBH250-200 5.5k 208/360 60H6	5.6843.32.13	9.186,98
2055011	CBH250-200 7.5k 208/360 60H6	5.6843.32.14	10.864,18
2055000	CBH250-200 11k 208/360 60H6	5.6843.32.16	11.226,48